

INSTALLER'S USER'S

Instructions and recommendations

Installer

AL

User

IE

IL

MK

MT

L048170ENG



COD. 3.034119

**VICTRIX PRO V2
CASCADE AND
ZONE
REGULATOR KIT**



INDEX

Dear Customer.....	5
General Recommendations.....	5
Safety symbols used.....	6
Personal protective equipment	6
1 List of abbreviations.....	7
2 Safety	9
2.1 General information.....	9
2.2 Structure of the warning instructions.....	9
2.3 Hazards due to water temperatures > 60 °C	9
2.4 Description of the product	9
3 System description.....	10
3.1 General information.....	10
3.2 System expansion.....	11
3.3 System overview.....	12
4 Components	13
4.1 Heatcon! MMI 200.....	13
4.2 heatcon! EC 1351 Pro.....	14
4.3 Heatcon EM 100	15
4.4 Heatcon! EM GBA.....	16
4.5 Heatcon! RC 130.....	16
4.6 Single room control heatapp!	17
5 Operation	18
5.1 heatcon! MMI.....	18
5.1.1 Basic display.....	18
5.1.2 Menu navigation	18
5.1.3 Menu overview	18
5.1.4 Configuring basic display.....	18
5.1.5 Speed button functions.....	18
5.1.5.1 Emission Measurement.....	18
5.1.5.2 Manual mode.....	19
5.1.5.3 Operating mode and scenes	19
5.1.5.4 Timer program	19
5.1.5.5 Information level.....	19
5.1.5.6 Comfort and economy temperature	19
5.1.5.7 Set-back temperature.....	19
6 Initial operation	20
6.1 Conditions and requirements.....	20
6.2 Initial operation using the setup wizard	20
6.2.1 Assignment of the inputs and outputs.....	20
6.2.1.1 Overview.....	20
6.2.1.2 Energy generator.....	21
6.2.1.3 Energy generator 2	21
6.2.1.4 Heating buffer.....	22
6.2.1.5 Hot water.....	22
6.2.1.6 Heating circuit 1...n.....	22
6.2.1.7 Differential 1.....	22
6.2.2 Setup wizard in heatcon! MMI.....	23
6.2.3 Setup wizard in the WEB browser (e.g. Mozilla Firefox, Google Chrome or similar)	26
6.2.3.1 Performing the initial setup.....	26

6.2.3.2	Establishment protocol (Establishment protocol)	30
6.3	Update heatcon! EC 1351 Pro	30
6.3.1	Installation Updates via USB Stick	31
6.4	Access data lost - Forgotten password	31
6.5	Forgotten password function	32
7	„System“ menu from PC/Laptop	35
7.1	Name heating system	35
7.2	heatapp! gateway	35
7.3	Establishment protocol	36
7.4	Notifications	36
7.5	Network	37
7.6	Date/Time	37
7.7	Setup wizard	38
7.8	System management	38
7.9	Expert (Technician)	39
7.10	monitor	39
8	Parameter description	41
8.1	Calling the expert menu	41
8.1.1	Heatcon MMI	41
8.1.2	heatapp! APP	41
8.1.3	PC user interface	42
8.2	Heatcon! MMI	43
8.3	menu – System	44
8.4	menu – room group 1 ... N	45
8.5	menu – heating circuit 1 ... N	49
8.6	menu – hot water (1) (2)	52
8.7	menu – Heating buffer (1) (2)	57
8.8	menu – total flow	60
8.9	menu – Cascade	61
8.10	menu – Energy generator	62
8.11	menu – solar	66
8.12	menu – Return flow	69
8.13	menu – extras	71
8.14	menu – difference	72
8.15	Fault message	75
8.16	menu - config	75
8.16.1	menu - information	75
8.16.2	menu - function	75
8.16.3	menu - hardware	84
8.17	menu - hydraulic	84
9	Troubleshooting	85
9.1	Display of fault messages	85
9.2	Fault messages of connected burner control systems	86
9.3	Heatcon! Error code	87
9.4	Fault messages	88
10	Technical data	96
10.1	Switching times table	97
10.2	Cable lengths and cross-sections	98
10.3	Resistance values for sensors of type KTY20	98
10.4	Resistance values for sensors of type PT1000	98
10.5	Notes	99

11	EbV - learning	101
12	System description.....	102
12.1	System overview	102
12.2	Heatcon! System.....	103
13	Heatcon! MMI 200.....	104
13.1	Basic display.....	105
13.2	Menu navigation	105
13.3	Menu overview	107
13.4	Configuring basic display.....	108
13.5	Speed button functions.....	109
13.5.1	operation mode and Scenes (Operating modes and scenes)	109
13.5.2	timer programs (Timer programs)	110
13.5.3	information (Information level).....	111
13.5.4	comfort temperature e economy temperature (Comfort and economy temperature)	112
13.5.5	Set-back temperature (Set-back temperature)	112
13.5.6	hot water (Hot water).....	113
14	Parameter description.....	114
14.1	MMI system menu	114
14.2	menu - hot water	114
14.3	menu - room group 1 ... N (Room 1 ... N).....	115
15	Heatcon! RC 130.....	117
16	Heatcon! Error codes	118
17	Switching times	119
18	Heatcon/heatapp system.....	120
18.1	Operation via app	120
18.1.1	Starting the app and logging on to the system.....	120
18.2	The "Home screen	122
18.3	Symbols in the rooms.....	123
18.4	Temperature setting by means of rotary wheel.....	125
18.4.1	Use of scenes.....	125
18.4.2	The menu "Settings".....	126
19	Notes	136

Dear Customer

Congratulations for having chosen a top-quality Immergas product, able to assure well-being and safety for a long period of time. As an Immergas customer you can also count on a Authorised Technical Service Centre, prepared and updated to guarantee constant efficiency of your products. Read the following pages carefully: you will be able to draw useful tips on the proper use of the device, compliance with which will confirm your satisfaction with the Immergas product.

For assistance and routine maintenance, contact Authorised Technical Service Centres: they have original spare parts and are specifically trained directly by the manufacturer.

GENERAL RECOMMENDATIONS



- All products are protected with suitable transport packaging.
 - The material must be stored in a dry place protected from the weather.
 - This instruction manual provides technical information for installing the kit. As for the other issues related to kit installation (e.g. safety in the workplace, environmental protection, accident prevention), it is necessary to comply with the provisions specified in the regulations in force and with the principles of good practice.
 - Improper installation or assembly of the appliance and/or components, accessories, kits and devices can cause unexpected problems for people, animals and objects. Read the instructions provided with the product carefully to ensure proper installation.
 - Installation and maintenance must be performed in compliance with the regulations in force, according to the manufacturer's instructions and by professionally qualified staff, meaning staff with specific technical skills in the plant sector, as envisioned by the law.
-

heatcon! system



Not all functions of the heatcon! system may be available, as it depends on your configurations. Plus the complete heatapp! system is not available (individual room control) because it is not provided by Immergas, while the heatapp! application is available (the heatapp! app requires a network connection; this may result in additional internet connection costs).

The manufacturer declines all liability due to printing or transcription errors, reserving the right to make any modifications to its technical and commercial documents without forewarning.

SAFETY SYMBOLS USED



GENERIC HAZARD

Strictly follow all of the indications next to the pictogram. Failure to follow the indications can generate hazard situations resulting in possible harm to the health of the operator and user in general, and/or property damage.



ELECTRICAL HAZARD

Strictly follow all of the indications next to the pictogram. The symbol indicates the appliance's electrical components or, in this manual, identifies actions that can cause an electrical hazard.



MOVING PARTS

The symbol indicates the appliance's moving components that can cause hazards.



DANGER OF HOT SURFACES

The symbol indicates the appliance's very hot components that can cause burns.



WARNINGS

Strictly follow all of the indications next to the pictogram. Failure to follow the indications can generate hazard situations resulting in possible minor injuries to the health of both the operator and the user in general, and/or slight material damage.



ATTENTION

Read and understand the instructions of the appliance before carrying out any operation, carefully following the instructions given. Failure to observe the instructions may result in malfunction of the unit.



INFORMATION

Indicates useful tips or additional information.



EARTH TERMINAL CONNECTION

The symbol identifies the appliance's earth terminal connection point.



DISPOSAL WARNING

The user must not dispose of the appliance at the end of its service life as municipal waste, but send it to appropriate collection centres.

PERSONAL PROTECTIVE EQUIPMENT



SAFETY GLOVES



EYE PROTECTION



SAFETY FOOTWEAR

1 LIST OF ABBREVIATIONS

Abbreviation	Description
A10VP	Output 0-10V / PWM
ABS	Setback mode
ADR	Address switch
AF	Outside sensor (OS)
AF2	Outside sensor 2 (OS2)
AGF	Exhaust gas sensor
ARS	Normally open relay output (ONOR)
ARSP	Normally open potential free relay output (ONOPR)
AT	External temperature
BCP	buffer charging pump
BDP	buffer discharge pump
BDV	buffer discharge valve
BE	Operator/Owner
BLZ	GEN / burner runtime (BRC)
BR1	Energy generator / burner stage 1
BR2 AUF	Energy generator / burner stage 2 ON
BR2 ZU	Energy generator / burner stage 2 OFF
BRSP	Burner block
BULP	buffer charging pump
BUS	System data bus
BUSFS	Solid fuel buffer sensor
BZ	GEN / burner runtime (BRC)
CBS	collector buffer sensor
CF	Common flow
CFS	Collector flow sensor
CHP	Feed pump
CIP	Circulation pump
CP	Condenser pump / HP main pump
CPS	DHW circulation pump sensor
DHC	Diverter valve heating circuit (heating/cooling)
DHCP	Dynamic Host Configuration Protocol
DHW	Hot water
DHWDI	Hot water diverter valve (DHWDI)
DIF1PF	Dif1 Buffer sensor
DIF1SOP	DIF1 Solar pump
DIF1VF	DIF1 Flow sensor
DIFF	Differential control
DP	delivery pump
DVV	Diverter valve
E/A	Input/Output I/O
ECO	ECO mode
EEZ	Energy generator
EFI	Sensor/pulse input (ISP)
EHWW	Electric heater hot water
EI	Pulse input

Abbreviation	Description
ELF	Discharge valve sensor heating buffer
ELH	DHW electrical heating element
EM	Extension Module
EO	Opto-coupler input (IOC)
FGS	Exhaust gas sensor
FKF	Solid boiler sensor
FMI	Fault message input
FPF	Solid buffer sensor
FS	Flow sensor (FS)
FSP	Solid fuel pump
GB	Device bus
GBA	Device bus adapter
GEN	Energy generator (GEN)
h2B	heatcon! 2-wire bus
HBD	Hydraulic buffer discharge
HK	Heating circuit (HC)
HCP	heating circuit pump
HF	Expert
HK1 OPEN	Heating circuit 1 valve open (HC1 OPEN)
HK1 P	Heating circuit 1 Pump
HK1 CLOSED	Heating circuit 1 valve closed (HC1 CLOSED)
HK2 OPEN	Heating circuit 2 valve open (HC2 OPEN)
HK2P	Heating circuit 2 Pump
HK2ZU	Heating circuit 2 valve closed (HC2 CLOSED)
HK3P	Heating circuit 3 Pump
HP	Heat buffer (HB)
HPE	Hydraulic buffer discharge (HBD)
HPP	Heating buffer pump
HTM	Heat quantity
IHDHW	Electrical heating usage hot water
I/O	Input/Output
KKP	Boiler circuit pump (BCP)
KSPF	Collector buffer sensor
KVLF	Collector flow sensor
LAN	Local Area Network
CEST	Central European Summer Time (CEST)
MMI	Control unit with display
MOD	Modulation
OEM	OEM manufacturer
OHC	Burner runtime
OS	Outside sensor
P	Pump
PEP	Buffer storage loading pump
PEV	Buffer storage unloading pump

INSTALLER

USER

Abbreviation	Description
PER	Parallel (H-GEN) GEN release
PF	Buffer storage sensor (BS)
PF1	Buffer storage sensor (BS) 1
PF2	Buffer storage sensor (BS) 2
PI Controller	Proportional-integral controller
PLP	buffer charging pump
PP	Primary pump
PWM	Pulse width modulation
PWF	Parallel energy generator activation
RC	Room Control
RED	Reduce mode
RF	Room sensor (RS)
RLB	Return flow limit
RLF	Return sensor
RLH	Return flow control/increase
S	Sensor
SBS	Solid fuel boiler sensor
SBUS	Solar collector buffer storage sensor
SCFS	Storage charging flow sensor
SCP	Storage charging pump
SCV	Storage charging valve
SF	DHW sensor
SFP	Solid fuel pump
SLP	Storage charging pump
SLV	Solar charge valve

Abbreviation	Description
SLVF	Solar charge valve sensor (SLVS)
SoCFS	Solar collector flow sensor
SMA	Fault signal output
SME	Fault signal input
SOP	Solar circuit pump
SoCFS	Solar collector flow sensor
SS	Storage sensor
STB	Safety temperature limiter
SVL	Sum flow
SVLF	Sum flow sensor
UHK	Diverter valve HC (heating/cooling)
ULV	Diverter valve
UWW	Hot water diverter valve (DHWDI)
VF (VLF)	Flow sensor (FS)
VF1	Flow sensor (FS) 1
VF2	Flow sensor (FS) 2
WEZ	Heat generator (oil/gas) (H-GEN)
WF	Heat generator sensor (boiler sensor)
WMZ	Heat meter
WW	Hot water
ZAF	Forced drainage
ZKP	Pump
ZKPF	Circulation pump sensor
ZUP	DHW recirculation pump

2 SAFETY

2.1 GENERAL INFORMATION

Any person charged with working on the device or system, must have read and understood this manual, especially the chapter on “Safety”.

Instruction may be necessary, dependent on the professional qualifications of the persons in question.

The relevant accident prevention regulations and other generally accepted safety regulations must be complied with.

2.2 STRUCTURE OF THE WARNING INSTRUCTIONS



Danger due to live parts.

Some components are electrically live. Contact with live parts can cause electric shock, burns or even death. Before working on the electrical system, observe the following points:

- **Switch the system to a zero volts state.**
- **Secure to prevent switching back on.**
- **Check for zero volts state.**

2.3 HAZARDS DUE TO WATER TEMPERATURES > 60 °C

During operation, there is a risk of scalding at all heating system hot water outlets in the following cases because of hot water temperatures > 60 °C:

- Automatic anti-legionella system

If the automatic anti-legionella system is activated, the domestic hot water will automatically be heated up to a temperature of 65 °C in order to kill legionella bacteria in the hot water system on the selected day and at the selected time.

- Automatic anti-legionella system

In the manual mode / emission measurement mode the domestic hot water can be heated up to the maximum possible boiler temperature because the burner and all pumps are switched on and the valves will be completely opened.

Heating and domestic hot water are not temperature controlled in these modes. These modes are especially used by the emission measurement specialist or by the installer in case the controller is defective.

However, the high water temperatures can be avoided if the boiler thermostat is adjusted to a max. boiler temperature of 60 °C.

Observe the following points to prevent scalding:

- Inform all users of the danger.
- Mix enough cold water or switch the domestic hot water loading pump off manually (if there is a switch at the pump).

2.4 DESCRIPTION OF THE PRODUCT.

Improper use, non-observation of these instructions, use of inadequately qualified personnel and independent changes exclude any liability on the part of the manufacturer for the resulting damage. The manufacturer's warranty becomes void.



Impairment of device function if incorrect spare parts are used!

If unauthorised parts are used correct functioning is not assured. Use spare parts authorised by customer service.

3 SYSTEM DESCRIPTION

3.1 GENERAL INFORMATION

The heatcon! system consists of the following components:

heatcon! EC 1351 Pro

The heatcon controller! EC is the main control unit of the system and the boiler or cascade boilers.

heatcon! MMI

The MMI is a control unit connected to the heatcon! EC 1351 Pro via BUS for operation of the entire system without an WEB browser.



If the initial system configuration is carried out via the MMI interface, the connection to the LAN network cannot be configured. The LAN network configuration can be carried out at a later time (refer to paragraph 6.2.3 “Setup wizard in the WEB browser (e.g. Mozilla Firefox, Google Chrome or similar)) without affecting what has already been set for the system.

heatcon! RC 130

The RC 130 room thermostat (zone manager kit) can be used as a remote control unit for groups of rooms via the wired bus.

heatcon! EM 100

The EM expansion module serves as an extension on the inputs and outputs of an EC-Base controller within the system.

heatcon! GBA 100

The heatcon! GBA is used to connect multiple heatcons! EC 1351 Pro together, including heatcons! EM 100.



The GBA does not amplify the signal, but only serves to facilitate the connection of the components.

Heatapp! app

The app is installed on mobile devices such as smartphones or tablets (iOS or Android) and is used to control heatcon! systems.

Heatapp! connect (remote access)

If you want to control your heating system from anywhere via heatapp! app, heatapp! connect must be activated. heatapp! connect must be activated in the via WEB browser-guided configuration of the heatcon! system (first configuration or subsequent). heatapp! connect is a web server and creates the connection when you access your heating with the app while under way.

heatapp! connect does not save any data. All data, access data and passwords are stored at home in the heatcon! EC and are only accessible to authorised users after login. This concept offers maximum data security.



If you know the local IP address of the heatcon! EC 1351 Pro via the router to which it is connected, you can also use the WEB browser-guided configuration for the initial configuration of the system (plumbing system and boilers). If the initial setup is done via “heatapp! Installation kit for the installer” or “heatapp! installation stick for the installer” described below, the local IP address of the heatcon! EC 1351 Pro can be seen from the initial “NETWORK” screen (the heatcon! EC must be connected via cable to the local LAN network).

Heatapp! Installation kit for the installer (Present in the “Tools kit for Remote management 2.0”)

The heatcon system! can be configured via WEB browser using the heatapp installation kit! (initial configuration, subsequent configuration, or configuration change). It contains a USB-LAN adapter and a LAN cable.

The installation kit is used to connect the heatcon! EC and the heatapp! gateway (not supplied by Immergas) with the PC/laptop for initial configuration, so that the user interface can called in the WEB browser.

ALTERNATIVE:

Heatapp! Installation stick for the installer (Present in the “Tools kit for Remote Management 2.0”)

The installation can also be performed via network connection via LAN (home network), but cannot be performed via WLAN (home WiFi network), since the WiFi network must be configured locally during initial/subsequent system setup via WEB browser (see heatapp !WLAN Stick present in the Tools kit for Remote Management 2.0).



If you know the local IP address of the heatcon! EC 1351 Pro via the router to which it is connected, you can also use the WEB browser-guided configuration for the initial configuration of the system (plumbing system and boilers). If the initial setup is done via “heatapp! Installation kit for the installer” or “heatapp! installation stick for the installer” described below, the local IP address of the heatcon! EC 1351 Pro can be seen from the initial “NETWORK” screen (the heatcon! EC must be connected via cable to the local LAN network).

3.2 SYSTEM EXPANSION

The heatcon! system can be expanded with the following components:

- Up to 3 heatcon! EC 1351 Pro basic controllers.
- Up to 6 heatcon! EM 100 expansion modules (maximum of two expansion modules per heatcon! EC basic controller).
- 1 heatcon! EM - GBA 100 expansion module for connecting multiple heatcons.
- heatcon! RC 130 room station at every heating circuit.

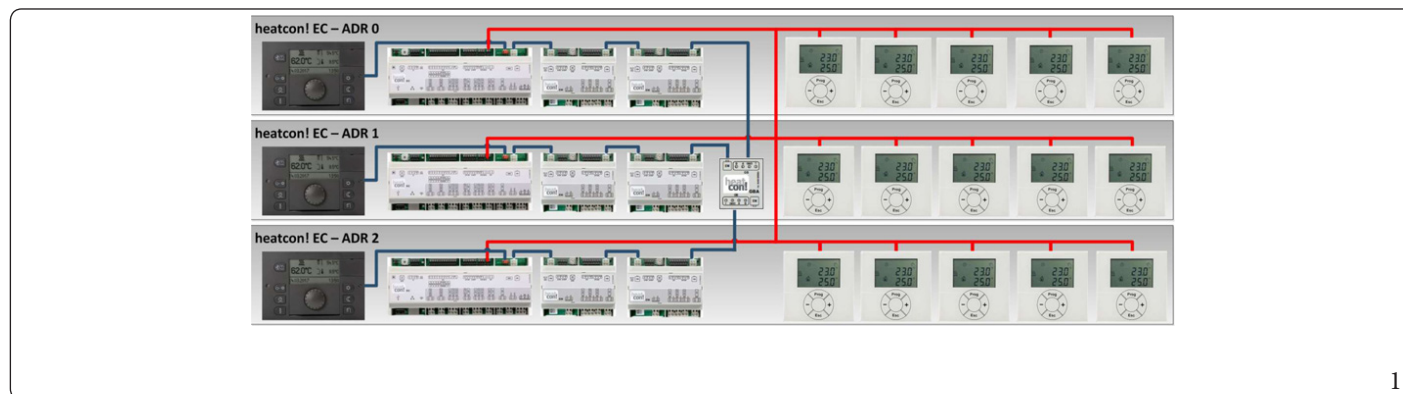

1



Invalid addresses 3... 15 are interpreted as address setting 0!

EC 1	ADR 0
EC 2	ADR 1
EC 3	ADR 2

3.3 SYSTEM OVERVIEW

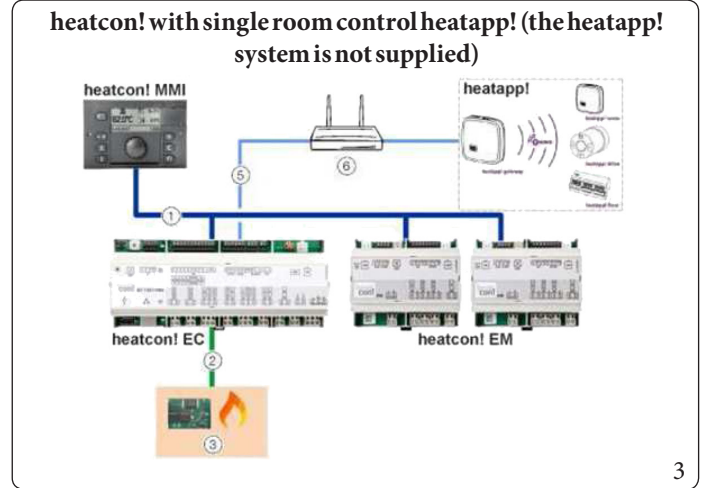
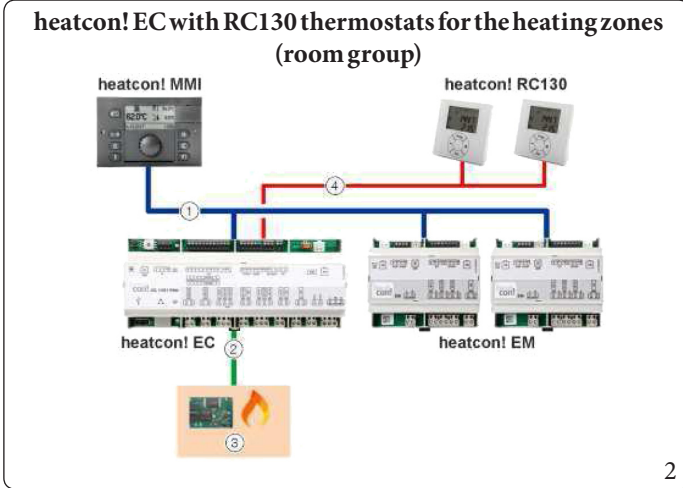

Key (Fig. 2- 3):

- 1 - EbV system bus
- 2 - GEN-Bus (energy generator)
- 3 - Energy generator
- 4 - EbV system bus
- 5 - Network connection (Ethernet)
- 6 - Router

4 COMPONENTS

4.1 HEATCON!MMI 200



Key (Fig. 4):

- | | | | |
|---|---|----|--|
| 1 | - Button "Emission measurement / manual mode" | 6 | - Button "Comfort/Economy temperature" |
| 2 | - Button "Scenes/operating modes" | 7 | - Button "Set-back temperature" |
| 3 | - Button "Programming" | 8 | - Button "Hot water daytime temperature" |
| 4 | - Button "Info" | 9 | - Display |
| 5 | - Cover service connection | 10 | - Rotarybutton (press & turn) |

The heatcon! MMI is the control unit for the heatcon! System for operation without an WEB browser. The buttons are used to call the corresponding menus.

Navigation through the menus and setting of values is performed using the rotary knob. For more information on operation, see chapter 5 "Operation".

At each heatcon! EC a heatcon! MMI can be connected.

The assignment is made directly to the desired heatcon! EC.

Connect to:	Address of EC:	N° MMI..:	Operation at:
EC 1	ADR0	MMI 1	heatcon-0
EC 2	ADR1	MMI 2	heatcon-1
EC 3	ADR2	MMI 3	heatcon-2



Setup of the heatcon! MMIs must be carried out one after the other, as the address assignment in the bus system is automatic.

4.2 HEATCON! EC 1351 PRO



The installation of the heatcon! EC is menu-driven. The inputs and outputs are preset as marked on the device. Free inputs and outputs can be used for other functions via advanced configuration (after Setup Wizard) (see also installation instructions and product documentation at <https://ebv-gmbh.eu/downloads>).

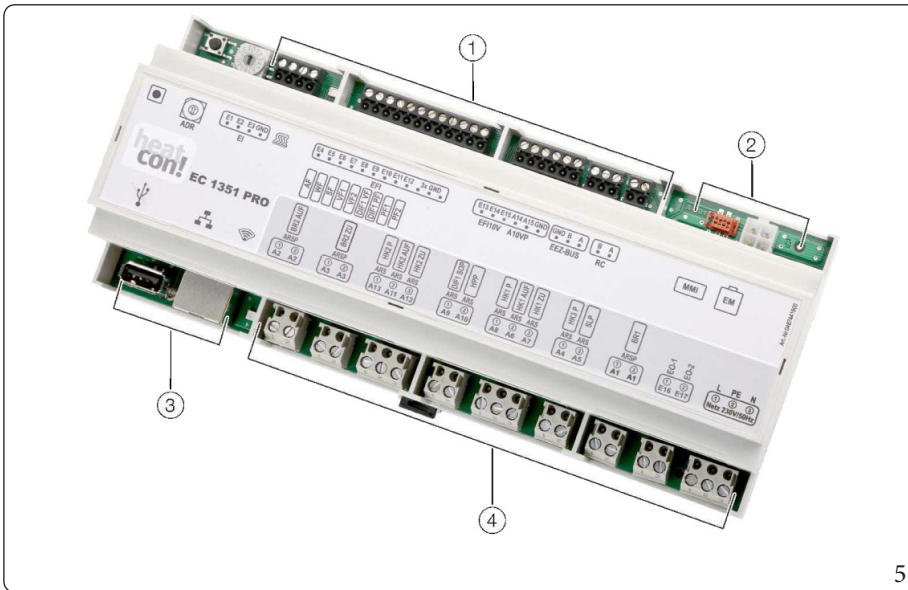

Key (Fig. 5):

- 1 - Low voltage connections
- 2 - Data bus for system expansion
- 3 - USB/network connection
- 4 - 230V connections

The heatcon! EC is the main control unit.

This is where all components (pumps, valves, sensors) of the heating system are connected and controlled. The energy generators are connected to the heatcon! EC (EEZ-BUS). The other heatcon! EC control options on the power generator are the classic potential-free relay contact or the 0-10V control.

For system expansion, further data bus connections are available. “USB/network connection” (Fig. 5) is to be used for initial configuration via WEB browser and for remote management.

“Data bus for system expansion” (Fig. 5) is to be used for connecting heatcon! EM 100.

4.3 HEATCONEM 100

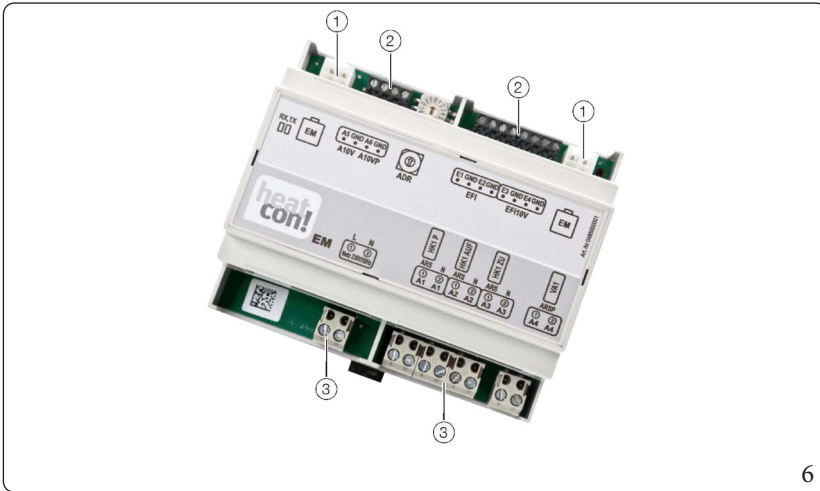

Key (Fig. 6):

- 1 - EbV system bus
- 2 - Low voltage connections
- 3 - 230V connections

The heatcon EM 100 is an expansion for the inputs and outputs of a heatcon! EC inside the system.

This is where all components (pumps, valves, sensors) of the heating system are connected and controlled.

The heatcon EM 100 is connected via the EbV-device bus with the heatcon! EC. Up to six heatcon EM 100 can be connected to the heatcon!-System (maximum two expansion modules per heatcon! EC basic controller). Addresses 0 ... 5 can be used with the rotary coding switch on heatcon EM 100. This allows e.g. 6 additional heating circuits to be connected. A maximum of 15 heating circuits are possible in the system.



The addresses 6-15 are without function.

The address settings on heatcon EM 100 have the following default functions:

Connect to:	Address of EC:	N° EM:	Address of EM:	Function
EC 1	ADR0	EM-A	ADR 0	heating circuit expansion 4 on EC 1
EC 1	ADR0	EM-B	ADR 1	heating circuit expansion 5 on EC 1
EC 2	ADR1	EM-A	ADR 2	heating circuit expansion 4 on EC 2
EC 2	ADR1	EM-B	ADR 3	heating circuit expansion 5 on EC 2
EC 3	ADR2	EM-A	ADR 4	heating circuit expansion 4 on EC 3
EC 3	ADR2	EM-B	ADR 5	heating circuit expansion 5 on EC 3

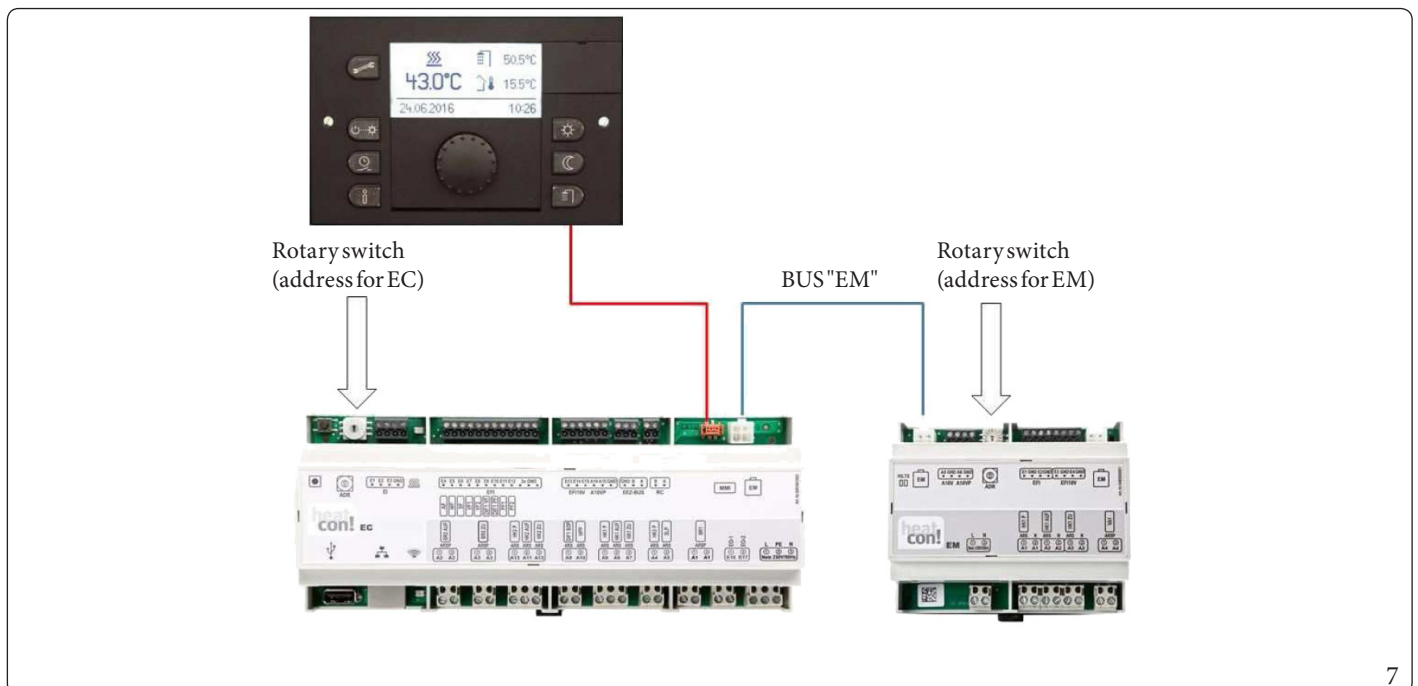

4.4 HEATCON!EM GBA



Key (Fig. 8):

- 1 - Device bus plug contact
- 2 - Device bus screw terminals

8

It is used to connect multiple heatcons! EC in cascade. This also applies if EM 100 expansions are present.

4.5 HEATCON!RC 130



9

RC130 serves as a zone remote control (room group) with room temperature measuring for the heatcon! system. The temporary desired temperature can be set with the + or - button. RC 130 is integrated into the heatcon! system by addressing and assigned to a room group (1 of max. 5) or, with individual room control, a room (1 of max. 24 - not available since not supplied by Immergas).

The heatcon! RC130 is connected via a 2-wire "RC" BUS to the heatcon! EC.

Each room group in the system a heatcon! RC 130 can be assigned.

Assignment of the RC130 to the active heating zones (room groups):

Connect to:	Address of EC:	N° RC130:	Address on RC130:
EC 1	ADR0	1	EC01 RC01
EC 1	ADR0	2	EC01 RC02
EC 1	ADR0	3	EC01 RC03
EC 1	ADR0	4	EC01 RC04
EC 1	ADR0	5	EC01 RC05
EC 2	ADR1	6	EC02 RC01
EC 2	ADR1	7	EC02 RC02
EC 2	ADR1	8	EC02 RC03
EC 2	ADR1	9	EC02 RC04
EC 2	ADR1	10	EC03 RC05
EC 3	ADR2	11	EC03 RC01
EC 3	ADR2	12	EC03 RC02
EC 3	ADR2	13	EC03 RC03
EC 3	ADR2	14	EC03 RC04
EC 3	ADR2	15	EC03 RC05

4.6 SINGLE ROOM CONTROL HEATAPP!



The heatapp system! it is not provided by Immergas, which is why it is not possible to control single rooms via the App, but it is only possible to control groups of rooms controlled by the heatcon! RC 130.

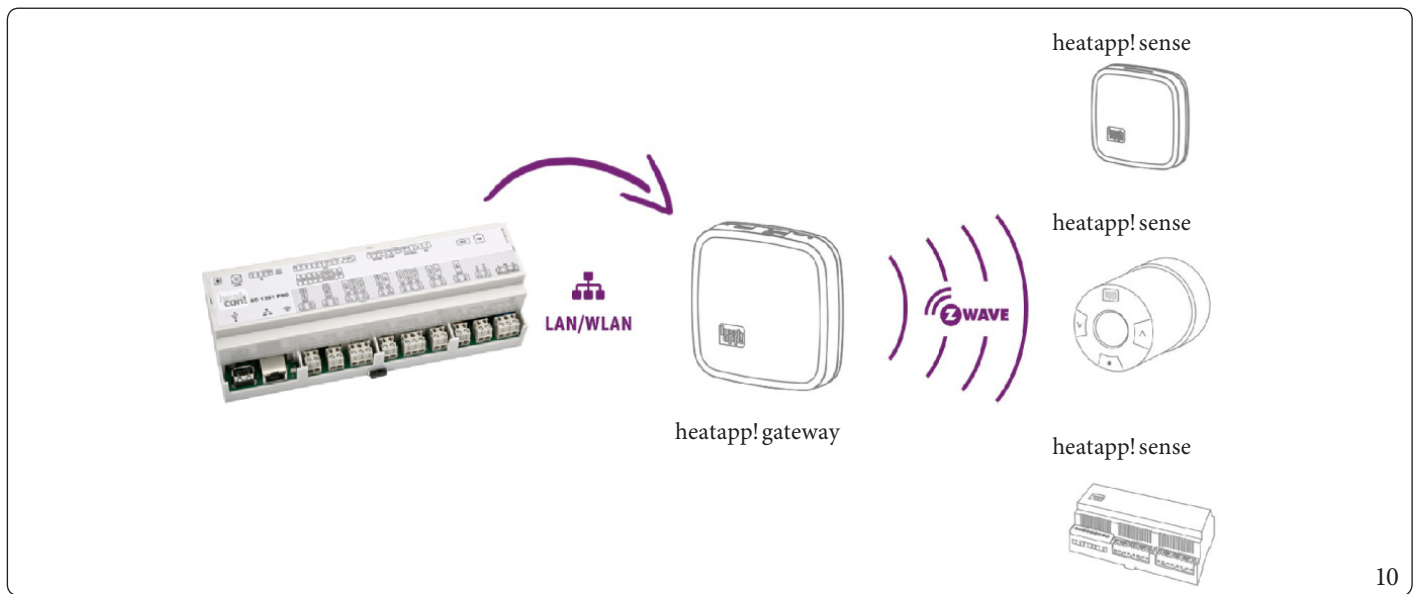

The heatcon! system can be expanded with the heatapp! system (Fig. 10) for wireless control of single rooms (up to 24 rooms). The system consists of the heatapp! Gateway which must be connected via LAN/WLAN to the heatcon! EC. Operation is via a tablet or smartphone using the heatapp! app. For more information about the heatapp! system see www.heatapp.de.

INSTALLER

USER

5 OPERATION

Heatcon! EC1351 PRO operation

Configuration and operation of the heatcon! EC PRO can take place in three ways:

- Configuration and operation via the control unit heatcon! MMI (in-situ).
- Configuration and operation via PC (in-situ).
- Configuration and operation via heatapp! App installed on a tablet or smartphone (it is not possible to carry out the first configuration through the App). Remote control and remote maintenance via the Internet is possible.

At home, the app accesses heatcon! EC PRO via the Wi-Fi connection of a tablet or smartphone. heatcon! EC PRO must be connected to the router and the Wi-Fi connection of the tablet or smartphone must be correctly configured.

Alternatively, access can also be made via secure connection, if heatapp! connect is activated.

5.1 HEATCON!MMI

See chapt. 13.

5.1.1 Basic display

See Par. 13.1.

5.1.2 Menu navigation

See Par. 13.2.

5.1.3 Menu overview

See Par. 13.3.

5.1.4 Configuring basic display

See Par. 13.4.

5.1.5 Speed button functions

See Par. 13.5.

5.1.5.1 Emission Measurement



Risk of scalding!

Risk of scalding during activated emission measurement by heating of the hot water above 60°C.

- Only qualified personnel may activate the “Emission Measurement” function.
- Before activating the “Emission Measurement” function, inform the users of the hot water system of the risk of scalding.
- When using hot water taps, mix in sufficient cold water.

If emission measurement is activated, the heat generator runs for 20 minutes at the maximum temperature limit set for the heat generator. The remaining time is displayed as it passes.

All heating circuits and DHW heating adjust their nominal value to the corresponding maximum temperature.

Activating:

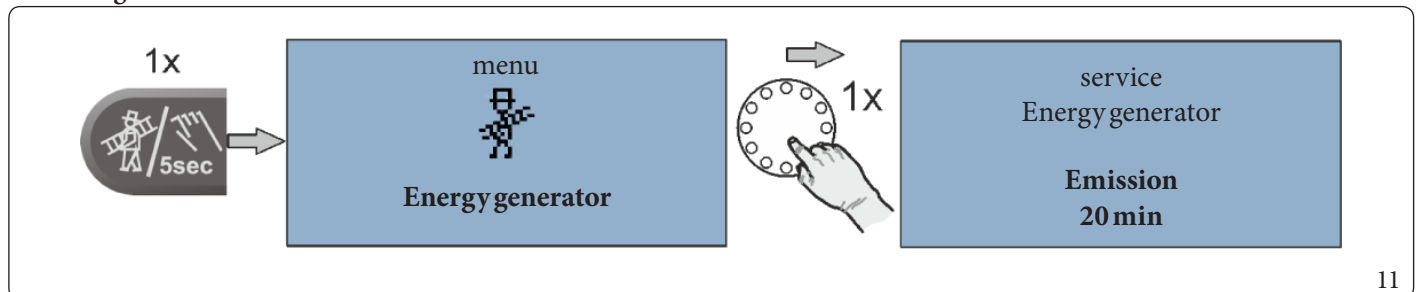

11

To activate emission measurement, press the Emission measurement/manual mode” button.

Deactivating:

To deactivate emission measurement, press the Emission measurement/manual mode” button again.

5.1.5.2 Manual mode

If manual mode is activated, the required heat generator temperature is set manually with the rotary button according to the relevant heat demand (does not have any effect if operated as a heating circuit expansion).

All the pumps are active, while the available mixing valves are de-energized and can be actuated by hand if required for the heat demand.

Activating:

1. To activate manual mode, press the “Emission measurement/manual mode” button for 5 seconds and then release.
2. Set the desired temperature of the energy generator using the rotary wheel. The setpoint is adjustable between the minimum and maximum temperature of the energy generator.
3. If necessary, manually adjust the mixers present in the heating circuits.

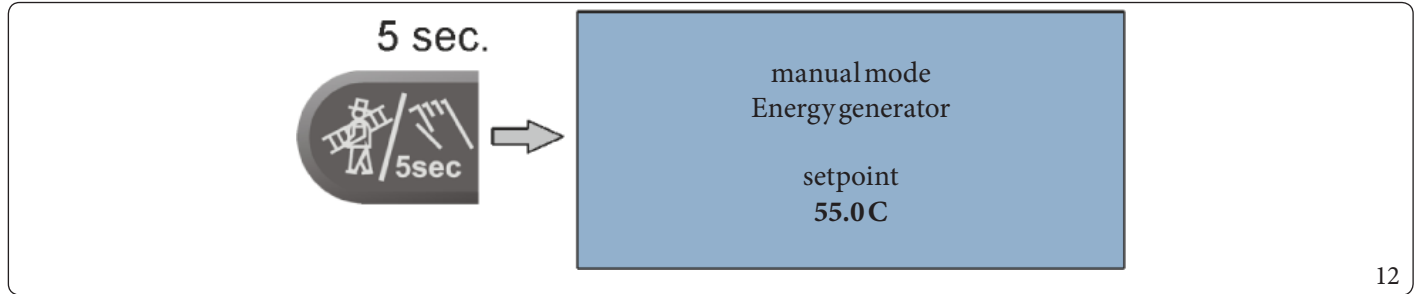

Deactivating:

To deactivate manual mode measurement, briefly press the Emission measurement/manual mode button.



- The heat generator maximum temperature limit takes priority over the heat generator switching differential and deactivates the heat generator if it is exceeded.
- The switching differential corresponds to the set switching differential for automatic control and is symmetrical to the setpoint temperature.
- With controllers that are operated purely as an expansion of the heating circuits, setting the temperature has no effect.
- The last value appears as a suggested value after the controller has adjusted to the heat generator temperature.

5.1.5.3 Operating mode and scenes

See Par. 13.5.1.

5.1.5.4 Timer program

See Par. 13.5.2.

5.1.5.5 Information level

See Par. 13.5.3.

5.1.5.6 Comfort and economy temperature

See Par. 13.5.4.

5.1.5.7 Set-back temperature

See Par. 13.5.5.

6 INITIAL OPERATION

6.1 CONDITIONS AND REQUIREMENTS

Prior to initial use of the controller, the following points must be fulfilled:

- The heating system must be made available in a fully complete state and filled with water to prevent damage to the pumps by dry running and to the energy generator by overheating.
- The controller must have been installed in compliance with the operating instructions.
- If an underfloor heating system is connected, then an additional limiting thermostat must be installed in the flow line downstream of the heating circuit pump to switch off the pump if the flow temperatures are too high.
- Prior to initial use of the controller all of the above requirements must be checked by a specialist.

6.2 INITIAL OPERATION USING THE SETUP WIZARD

The system setup wizard is available for the initial configuration of the heatcon! system:

- • Setup wizard in heatcon! MMI, see chapter 6.2.2.
- Guided configuration via WEB browser, see chapter 6.2.3.



During initial operation using the setup wizard, the assignment of the electrical inputs and outputs is performed according to the tables in the chapter 6.2.1 "Assignment of the inputs and outputs."

6.2.1 Assignment of the inputs and outputs

6.2.1.1 Overview

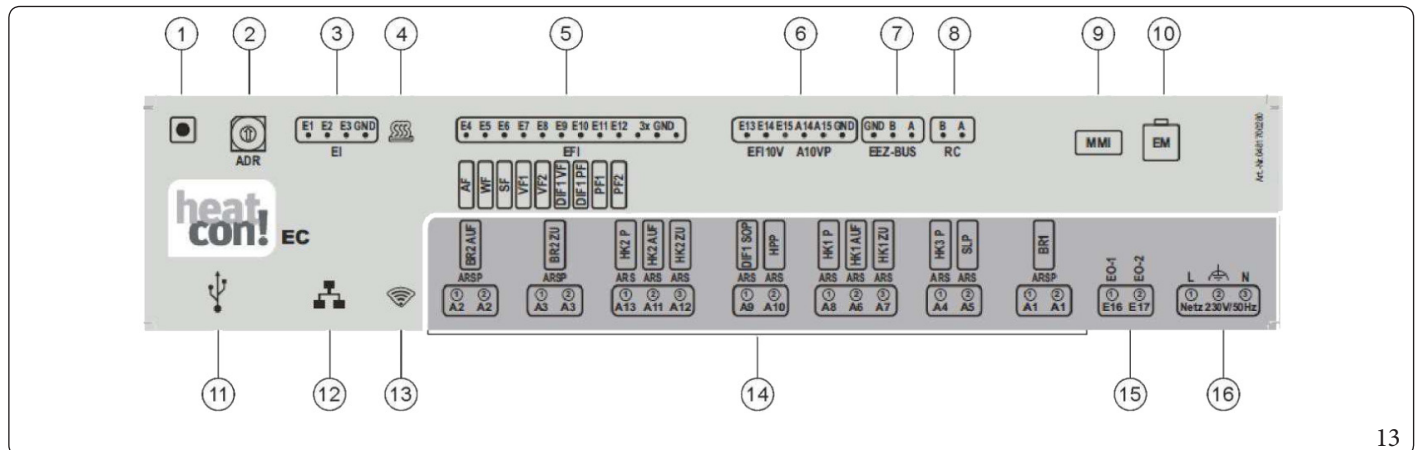

Key (Fig. 13):

- | | |
|---|---|
| <p>1 - Push-button: not used</p> <p>2 - Address selector: to be used when using 2 or more heatcon! EC 1351 Pro</p> <p>3 - Digital inputs: pulse sensor input</p> <p>4 - "Control" LED: displays the status of the connected device and BUS communication</p> <p>5 - Temperature sensor inputs: Connect analog temperature sensors here</p> <p>6 - Analog Inputs/ Analog Outputs (0-10V)</p> <p>7 - Bus for the energy generator: connect the appliance BUS here</p> <p>8 - H2B 2-wire bus for zone manager: connect the heatcon! zone manager(s) RC 130</p> <p>9 - Heatcon! MMI connection!: Connect the MMI 200 control interface here</p> <p>10 - System bus for heatcon! EM 100: connect heatcon! EM 100 expansions here</p> | <p>11 - USB connection: to be used for connecting the components of the Tools kit for Remote Management 2.0 (initial/ subsequent configuration alternative to using the MMI 200 interface, to connection via WEB browser), for backing up the configuration (a USB stick is required and internet connection), and for updating the heatcon! EC 1351 Pro firmware (FAT32 Linux: USB stick required)</p> <p>12 - Network connection (Ethernet, RJ45): to be used for initial/ subsequent configuration via WEB browser, for remote management and for updating the heatcon! EC 1351 Pro firmware</p> <p>13 - "Network" LED: displays the status of the internet connection</p> <p>14 - Outputs (230V AC): connect the circulators and valves here (ARSN.O. contact relay terminal – LINE; ARSPN.O. clean contact relay terminals)</p> <p>15 - Digital inputs (230V AC): input opto-isolator for operating hour counter</p> <p>16 - Power supply: 230 V ±10%, 50 Hz</p> |
|---|---|

6.2.1.2 Energy generator

Standard connection assignment energy generator.

Individual setting (Display)	Configuration	Connections
single-stage burner	Energy generator function → Single-stage burner	A1 → BR1 E5 → WF
two-stage burner (the configuration cannot be used with Immergas appliances)	Energy generator function → Two-stage burner	A1 → BR1 A2 → BR2 E5 → WF
power signal on/off	Energy generator function → Modulating OFF/ON	A1 → BR1 A2 → BR2 AUF A3 → BR2 ZU E5 → WF
burner control system (OT/Bus)	Energy generator function → Control system	EEZ-Bus A/B
temperature signal 10V	Energy generator function → Actuator signal 0-10V	A1 → BR A14 → A10VP E5 → WF
release contact	Energy generator function → Switch contact	A1 → BR
power signal 10V	Energy generator function → Modulating 0-10V	A1 → BR A14 → A10VP E5 → WF

6.2.1.3 Energy generator 2

Standard connection assignment energy generator.

Individual setting (Display)	Configuration	Connections
single-stage burner	Energy generator function → Single-stage burner	A2 → BR1 E13 → WF
burner control system (OT/Bus)	Energy generator function → Control system	EEZ-Bus A/B
temperature signal 10V	Energy generator function → Actuator signal 0-10V	A15 → A10VP
release contact	Energy generator function → Switch contact	A2 → BR
power signal 10V	Energy generator function → Modulating 0-10V	A2 → BR A15 → A10VP E13 → WF

*Adjustability according to EEZ1 occupancy

6.2.1.4 Heating buffer

Standard connection assignment heating buffer.

Individual setting (Display)	Configuration	Connections
charge control	Heating buffer function → Charging control	A10 → HPP E11 → PF1
discharge control 1	Heating buffer function → Discharge control 1	E11 → PF1
discharge control 2	Heating buffer function → Discharge control 2	E11 → PF1

6.2.1.5 Hot water

Standard connection Hot water function.

Individual setting (Display)	Configuration	Connections
Storage tank load pump	Hot water function → DHW storage charging pump	A5 → SLP E6 → SF
DHW circulation pump	Hot water function → DHW circulation pump.	A5 → ZKP E6 → SF
burner control system (OT/Bus)	Hot water function → Control system	EEZ-Bus A/B
heating usage	Hot water function → Heating usage	A5 → ELH E6 → SF

6.2.1.6 Heating circuit 1...n

Standard connection assignment heating circuit 1.

Individual setting (Display)	Configuration	Connections
Non-mixed circuit	Heating circuit 1 function → Pump	A8 → HK1P
Mixed circuit	Heating circuit 1 function → Valve	A8 → HK1P A6 → HK1AUF A7 → HK1ZU E7 → VF1

6.2.1.7 Differential 1

Standard connection differential controller.

Individual setting (Display)	Configuration	Connections
solar	Differential 1 function → Solar	
	Flow sensor: E9:EFI	E9 → DIF1:VF
	DHW storage sensor: E10:EFI	E10 → DIF1:PF
	Pump relay: A9:ARS	A9 → SOP
Solid fuel	Differential 1 function → Solid fuel	
	Flow sensor: E9:EFI	E9 → DIF1:VF
	DHW storage sensor: E10:EFI	E10 → DIF1:PF
	Pump relay: A9:ARS	A9 → FSP
difference	Differential 1 function → Differential	
	Flow sensor: E9:EFI	E9 → DIF1:VF
	DHW storage sensor: E10:EFI	E10 → DIF1:PF
	Pump relay: A9:ARS	A9 → DIF1P



As standard, temperature sensor input E9 is configured as the connection for PT1000 temperature sensors.

6.2.2 Setup wizard in heatcon! MMI

The setup wizard of the heatcon! system guides you in seven steps through the basic settings of the system.



No access data are adjusted via heatcon! MMI nor are any network settings made.
If operation is subsequently to take place via the heatapp! App, the first setup must be carried out using a PC/laptop.

After switching on the power supply, the assignment of the MMI to the heatcon! EC starts.

By default EC1 with address 0 is selected. After the assignment, the setup wizard starts automatically in heatcon! MMI.

Press the rotary button to start the configuration.

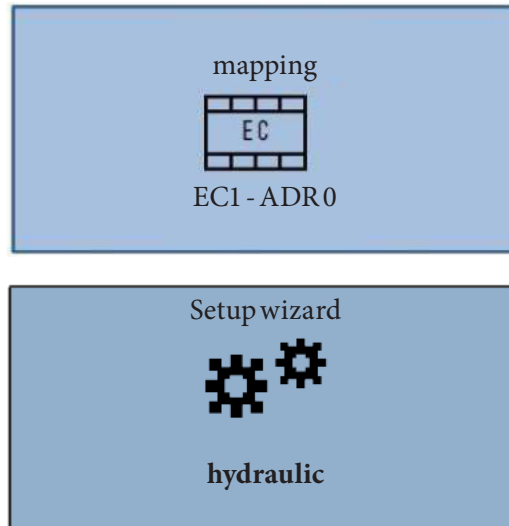

14

Step 1: Languages

Setting options:

- DE = German
- GB = English
- FR = French
- IT = Italian
- NL = Dutch
- PL = Polish
- ES = Spain
- TR = Turkish
- RU = Russian

Step 2: Selection of the energy generator function-1

Select the energy generator function.

Wizard
hydraulic
Energy generator
function
off

15

Setting options:

- off
- single-stage burner
- two-stage burner (the configuration cannot be used with Immergas appliances)
- Off/On modulation
- Access system
- Actuator signal 0-10V
- release contact
- power signal 10V

Step 3: Selection of the energy generator function-2

Select the energy generator function.

Wizard
hydraulic
Energy generator
function
off

16

Setting options:

- off
- single-stage burner
- Off/On modulation
- Access system
- Actuator signal 0-10V
- release contact
- power signal 10V

Step 4: Selection of the heating buffer function

Select the heating buffer (buffer storage) function.

Wizard
hydraulic
Heating buffer
function
off

17

Setting options:

- off
- Loading control
- Drain 1 control
- Drain 2 control

Step 5: Selection of hot water heating

Select the hot water heating function.

	Wizard hydraulic hot water mode function off		18
--	---	--	----

Setting options:

- off
- DHW storage tank load pump
- DHW recirculation pump
- Control system
- Central heating use

Step 6 to 8: Selection of the function for heating circuit 1...3

Select the function of heating circuits 1 ... n.

	Wizard hydraulic heating circuit 1 function off		19
--	--	--	----

Setting options:

- off
- Non-mixed circuit
- Mixing circuit (for HC 1 + 2 only)



Only the actual hardware heating circuits are automatically displayed in the setup wizard. For mixed heating circuits, configure heating circuits 1+2, heating circuit 3 can only be used as an unmixed circuit.

Step 9: Selection of the function for differential control

Select the differential control function.

	Wizard hydraulic differential control 1 function off		20
--	---	--	----

Setting options:

- off
- solar
- Solid fuel
- difference

Finished!

The initial setup of the heatcon! system is now complete. The system has created a room group for each configured heating circuit. All parameters and temperatures are set to the basic settings.

The assignment of the electrical inputs and outputs corresponds to the tables in chapter "Conditions and requirements".

Further configuration takes place via the menu of heatcon! MMI, see chapter "Menu overview".

6.2.3 Setup wizard in the WEB browser (e.g. Mozilla Firefox, Google Chrome or similar)

Connecting the heatcon! EC 1351 Pro to the Ethernet network via the Rj45 socket (ref. 12 of figure 13), you can configure the system via the browser with the PC / Laptop, or the Smartphone / Tablet, rather than via MMI 200.

To do this you need to know the IP address of the heatcon! EC 1351 pro assigned by the router. Connect the PC / Laptop, or the Smartphone / Tablet, to the same Ethernet network where the heatcon! EC is connected. By entering the IP address of the heatcon! EC in the Browser the heatcon! guided configuration menu starts.

To facilitate the initial configuration, or configurations subsequent to the initial one performed with the MMI200 interface, the "Tools kit for remote management 2.0" may be useful.

6.2.3.1 Performing the initial setup

The setup wizard of the heatcon! system guides you in seven steps through the basic settings of the system.

Step 1 - Login

- Login as an expert to heatcon! EC.



It is not necessary to login to the system for the initial configuration.

The login is used for subsequent accesses.

Step 2 - Network

For the initial configuration of the system, but also for subsequent ones, an Internet connection is not necessary (it is sufficient to be connected to the home network).

Without an Internet connection it will be possible to connect to the heatcon! from smartphone or tablet only in the local network, but not when travelling or far from the system.

Furthermore, without an internet connection it is not possible to download updates for heatcon! EC 1351 pro.

21

Creating a network connection

- A LAN connection via DHCP is recommended (automatic setup of an Internet connection)
- LAN connection with manual settings (optional)
- Setup of a proxy connection (optional)

After an Internet connection has been created, the heatcon! system checks if an update is available.

- If a system update is available, an installation request appears. If the update is not installed, an initial setup cannot be performed.



This step is omitted if no Internet connection is available.

- Connection to heatapp! connect for remote control of the heatcon! system. Heatapp! connect is required so that the system can subsequently be operated via the app from any location.



At the end of the initial setup, you can access the heatcon system! in the following ways:

- heatapp! connect disabled (default), you can access the heatcon! only via the local network from the APP (heatapp! app) and from the browser.
 - heatapp! connect enabled, as in the previous case, but the APP can also be accessed from outside the local network.
- The heatapp system! it is also accessible via WEB browser from the local network, but not via the "User" profile.



From the APP ("Administrator" or "Expert" profile) and from the Browser you have many common functions.

From the APP it is not possible to carry out the first configuration of the NETWORK, complete monitoring is not available, the temperatures of the "group of rooms" can be set, while from the Browser it is not possible to set the temperatures of the "group of rooms", but complete monitoring and the first NETWORK configuration can be performed."

Network → energy generator → rooms → name heating system → user → date / time		
energy generator		
1	energy generator 1 Type: single-stage burner name: --	✓
2	energy generator 2 Type: single-stage burner name: --	✓
3	heating buffer Type: charge control name: --	✓
4	Domestic hot water Domestic hot water storage pumps name: --	✓
5	heating circuit valve 1 Heating circuit 1 mixer circuit name: --	✓
6	heating circuit valve 2 Heating circuit 2 mixer circuit name: --	✓
7	heating circuit 3 Heating circuit 3 heating circuit name: --	✓
8	differential control 1 Differential control type: user name: --	✓
9	Single room heat regulation Single room heat regulation: off	✓

22

Step 3 - Hydraulics

The heatcon! system offers series of configuration models, the hydraulic schemes of which can be selected at this point. The other menu selections change depending on which selection is made on this page.

All available heating circuits are automatically displayed in the setup wizards.

- Configure the parameters according to the requirements of the heating system.

Selection of single room control

- Select whether the connection to the single room control heatapp! is available.



Immergas does not provide the heatapp system! to control single rooms, so always set this option "off".

Step 4 Room groups and Rooms

Network ✓ > energy generator ✓ > rooms ✓ > name heating system ✓ > user ✓ > date / time ✓

rooms and roomgroups

Register the rooms for single room control, to be controlled with heatcon! Without single room control a room group for each heating circuit is displayed. The name displays the controlled rooms.

1
room 1 heating circuit 1
room name heating circuit 1 | room supply heating circuit 1

Here you can change the default name, which is used in the skilled area. Optionally, correct the supply room.

room name:

room supply:

Delete
back
save

2
room 2 heating circuit 2
room name heating circuit 2 | room supply heating circuit 2
✓

3
Create a new heating zone
+

23

Without single room control heatapp!:

A room group is created for each heating circuit. All the data relevant to the room group such as temperatures, timer programs etc. can be individually adjusted for the room group and do not affect the entire system.

The room group setting act immediately on the assigned heating circuit.

With single room control heatapp!:



The heatapp system! it is not supplied by Immergas, so select “off” under “Single room heat regulation”.

Here you create all rooms that are to be regulated by heatapp! and assign the rooms to the room supply.

The room supply controls at which point the requirement is created so that the room is supplied with the necessary heat.

Step 5 - My System

Network ✓ > energy generator ✓ > rooms ✓ > name heating system ✓ > user ✓ > date / time ✓

name heating system

Fill in here the name of your heating system. This name is shown later in the heatapp! app. As plant location please fill in the postcode name of your residence to display the weather data.

name heating system:

plant location:

24

Allocate a name to your heatcon! system and enter the location (town and postcode). The entered location is used to display the weather data in the heatapp! App.

Step 6 - Users

Network ✓ energy generator ✓ rooms ✓ name heating system ✓ user ✓ date / time ✓

user

To use the heatcon! ec, the user must with username and password to login. Register at least two users who have the roles:

- Expert, for full access to all settings
- Owner, for individualisation and user management

Additional users can be added to at a later date.

Caution:
Without login credentials is the use of the heatcon! ec not possible!
Keep the data.

+ Please create a new user.

1	admin Mr. Admin Admin user role: Expert	>
2	owner Mr. Owner Owner user role: owner	>
3	user Mr. User User user role: user	>

Please create a new user.

user role: Please choose user name:

title: password:

Mr. first name: Repeat your password:

name:

create

25

To be able to operate the heatcon! system, the users must login to the system with user name and password. Create at least two users with the following user roles:

- Expert for complete access to all settings
- Owner, for customisation and user management

Further users can be added at a later date.



Use of the heatcon! system without access data is not possible either in the app or from a PC. Therefore keep the access data somewhere safe.

Creating users:



The user name must be at least 5 characters long. Allowed characters are upper case and lower case letters A-Z (a-z), special German characters äöüß, numbers 0-9 and special characters @-._.

The password must contain at least 5 characters from two of the following character groups: Lower case letters, upper case letters, special characters, numbers.

1. Select the user role.
2. Enter first and last name of the user.
3. Enter the user name.
4. Assign a password for the user.
5. Save the user by clicking on “Create”.

Step 7- Date and time

26

Here you select the time zone for your location (town of residence). You can select between the following variants:

- Time synchronisation via the Internet
- Time synchronisation via an internal NTP server
- Manual time setting

Finished!

The initial setup of the heatcon! system is now complete. All parameters and temperatures are set to the basic settings. The assignment of the electrical inputs and outputs corresponds to the list in section "Assignment of the inputs and outputs". Further configuration takes place via the "Expert" menu. For further parameter configuration, consult the application diagrams of the appliance/boiler.

6.2.3.2 Establishment protocol (Establishment protocol)

In the "Establishment protocol" area, an establishment protocol can be generated and sent by e-mail. The establishment protocol contains all information of your heatcon! configuration.

Generate Establishment protocol

- Tap on the "Generate a new establishment protocol" button to create a protocol.

The establishment protocol is stored in the heatcon! EC until a new one is built.

This allows you to access at the last establishment protocol at any time ("Show establishment protocol" button) and/or send a PDF by e-mail ("Send establishment protocol" button).

Sending the establishment protocol by e-mail (only with "heatapp! connect" enabled).

1. Tap on the "Add a new e-mail address" button.
2. Enter the email address to which the establishment protocol is to be sent. You can enter multiple e-mail addresses.
3. Press the "Send establishment protocol" button to send the protocol.

If sending was successful, a corresponding message is displayed.

Use the button  to return to the "System" menu.

6.3 UPDATE HEATCON! EC 1351 PRO

If the heatcon! EC is connected to the Internet and the installation is done via PC/Laptop/Smartphone or Tablet, the system will ask you to install a potentially available update during the initial setup. Alternatively updates can be made via USB stick if an Internet connection is not possible or not desired.



Updates are provided to introduce new features and fix bugs. Therefore, it is always a good idea to perform an available update.

OEM partners and specialist companies have access to the available update files via EbV - Support. The update files are encrypted and signed so that the security of your data and the system is guaranteed at all times. The system checks whether there is a suitable update file on the USB stick. This ensures that only suitable update files are installed. An exchange of the files (the USB update system is available for all heatcon! and heatapp! devices), e.g. by renaming, is therefore impossible.

6.3.1 Installation Updates via USB Stick



- For the update via USB stick, use an empty USB stick formatted in FAT32 (Linux) and with a maximum size of 32 GB (the update file can also be inserted into the USB stick using a PC with a Windows system).
- The update does not delete data and configuration, but it may be useful to perform a data backup ("System management" menu).

Save the update file on the USB stick.

Plug the USB memory stick into the USB port of the heatcon! EC. The LED signals the update process:

LED flashes cyan (blue)	Update file is read
LED static green or yellow	Update will be installed
LED 5 sec. red and then green	Update failed (e.g. because the update file on the USB stick is incorrect)
LED 5 sec. fuchsia (purple) then red	System is in recovery status



Do not disconnect the power supply to the heatcon! EC and the USB stick during the update.

The actual update process takes between three and eight minutes. The USB memory stick can then be removed and the system can be set up or, if setup is already complete, normal operation can begin.



If updates are not performed regularly, but you later decide to update the heatcon! EC with the latest version available, thus skipping some intermediate updates, the update process via the internet may no longer be possible, while via USB stick it may take around 30 minutes or be impossible.

6.4 ACCESS DATA LOST - FORGOTTEN PASSWORD

During the setup of the heatapp! system, access data is created. For this purpose, a user with the expert role and a user with the administrator role must be created. The access data consists of a user name and password.

This function can be used to replace the access data.



For the "Forgot password" function, use an empty USB stick formatted in FAT32 (Linux) and with a maximum size of 32 GB.

6.5 FORGOTTEN PASSWORD FUNCTION

The function is only available in the local network and must be executed via a web browser.

The wizard of the “Forgot password” function can be called up via the web browser.

When the wizard is executed, new access data is created for a user with the expert role and a user with the owner role.

The Forgot Password Wizard ends with the saving of a txt document, which is saved on a USB stick.

When this USB stick is plugged into the al heatcon! EC base, the device first checks the file on the stick. If there are suitable access data for an expert and an owner here,

- all previous users with the respective rights are deleted.
- all devices connected to the system are logged out (both via the web browser function and in the app).
- the new access data for a specialist and an administrator and, if available, a new password for the gateway, are read in (the Gateway is part of the heatapp! system not supplied by Immergas).

This function protects the users from unauthorised changes of the access data by third parties, as all authorised users become aware of the password change through the logout.



If the forgotten password function is executed on a tablet or smartphone, it must be ensured that the file created can subsequently be saved on a USB stick.



The "Forgot password" link is located below the login screen.



The wizard guides you step by step through the function so that new access data can be generated for the system.

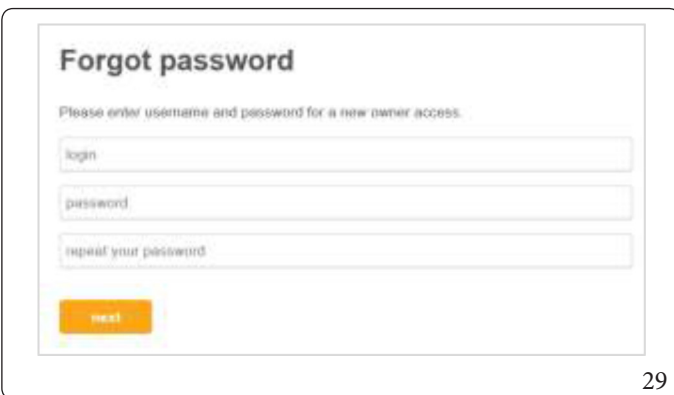

First, the user name and password for a new owner access must be created.



30

Then the user name and password for a new expert access is created.

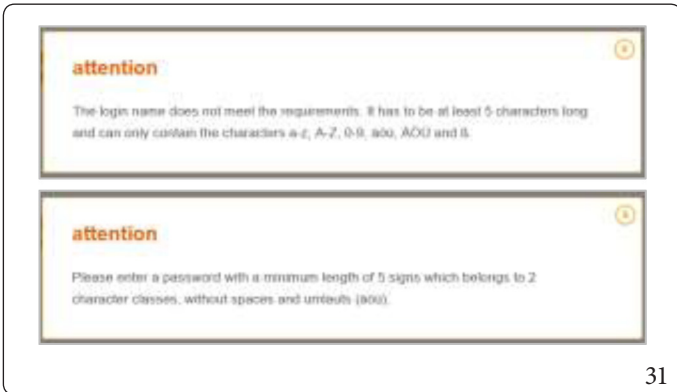

31

The system automatically checks whether the new access data meet the necessary requirements. If this is not the case, a note appears.



32

If a gateway (not supplied by Immergas) is connected to the heat-con! EC, a new password for the gateway can be assigned here.



33

Download the file to your PC/Laptop.



34

and save it on an empty USB stick.



35

Plug the USB stick into the heatcon! EC for approx. 5 seconds. The unit checks the file if it is OK,

- all previous users with respective rights are deleted;
- all devices connected to the system are logged out (both via the web browser function and in the app);
- the new access data for a specialist and an administrator and, if available, a new password for the gateway, are created.

You can then log in with the new access data.



36

If the USB stick is plugged into the PC/laptop after the password has been changed, the log file can be displayed in addition to the password file.

By opening the files, you can read out the contents.

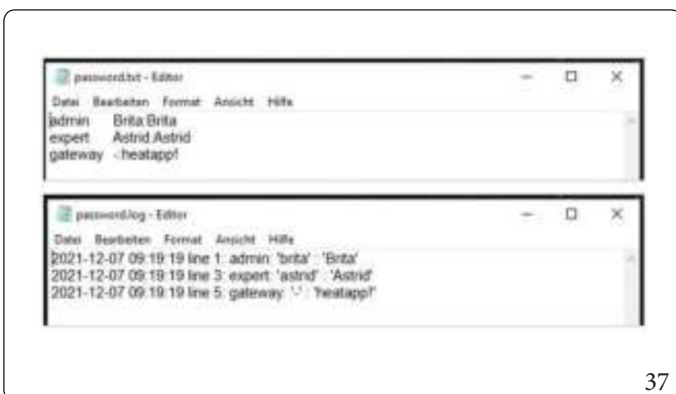

37

By opening the files, you can read out the contents.

7 „SYSTEM“ MENU FROM PC/LAPTOP



In the "System" area you have access to the complete menu of the **heatcon! System**.



The menu of the **heatcon! System** can also be accessed via IP address on a PC or laptop in the local network. How to find out the IP address of your **heatcon! System**, refer to chapter 7.5 "Network".

7.1 NAME HEATING SYSTEM

In the "Name heating system" area you can edit the name and location of the **heatcon!** system.

Detailed information about **heatcon! EC** and **heatapp! gateway** (Immergas does not make the **heatapp** system available!) are also displayed here.

1. Tap on the corresponding input fields to change the system name or system location.
2. Tap on "Save" to apply the settings.

Use the button  to return to the "System" menu.

7.2 HEATAPP! GATEWAY



Immergas does not make the **heatapp** system available!

7.3 ESTABLISHMENT PROTOCOL

In the "Establishment protocol" area, an establishment protocol can be generated and sent by e-mail. The establishment protocol contains all the information about your **heatcon! EC** configuration (see 6.2.3.2).

Generating the establishment protocol.

- A new report is created by tapping on the button "Generate a new establishment protocol".

The establishment protocol is saved in the **heatcon! EC 1351 Pro** until a new establishment protocol is generated.

This means that at any time you can access the last generated establishment protocol (button "Show establishment protocol") and / or send a PDF by e-mail (button "Send establishment protocol").

Sending an establishment protocol by e-mail.

1. Tap on the "Add a new e-mail address" button.
2. Enter the new e-mail address to which the establishment protocol is to be sent. You can enter multiple e-mail addresses.
3. Tap on "Send establishment protocol" to send the establishment protocol.

If the establishment protocol has been sent successfully, a corresponding message is displayed.

Use the button  to return to the "System" menu.

7.4 NOTIFICATIONS

The heatapp!_system sends push and e-mail messages in the event of faults or service notifications.

Push messages are system notifications, which the **heatcon! EC 1351 Pro** sends directly to the user interface of the mobile device (smartphone / tablet), so that the user is immediately informed. These may be fault messages or service notifications.

E-mail addresses that are to be used for the sending of automatic push messages can be saved under the "Notifications" menu item. These e-mail addresses can likewise be offered as possible distribution addresses when sending the establishment protocol.

Tap on the desired users to specify which individual users are to receive the notifications.

Use the button  to return to the "System" menu.

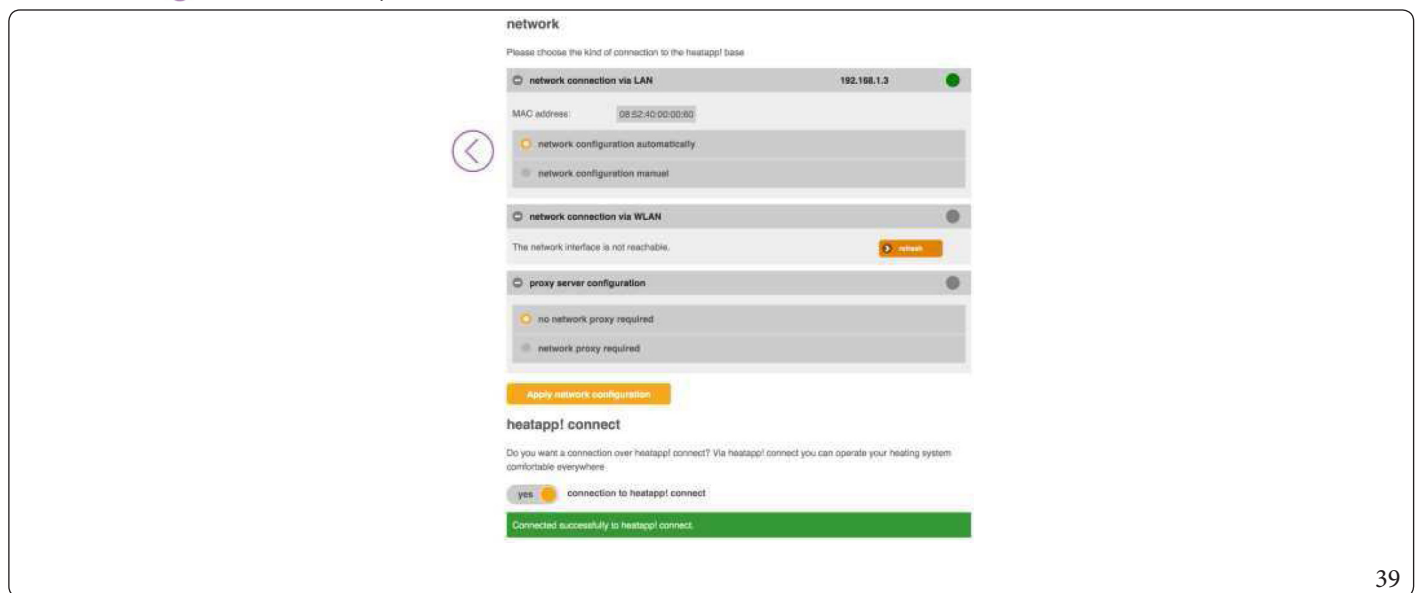

7.5 NETWORK

The current network settings are displayed in the "Network" area.

This is where you can change the network configuration, e.g. if for example a Wi-Fi is to be set-up after the initial configuration. You can also activate the connection to **heatapp!connect** from here.

You can also activate the continuous improvement process here to send anonymous reports to heatapp!. In this way you actively help to improve the system further.

Use the button  to return to the "System" menu.

7.6 DATE/TIME

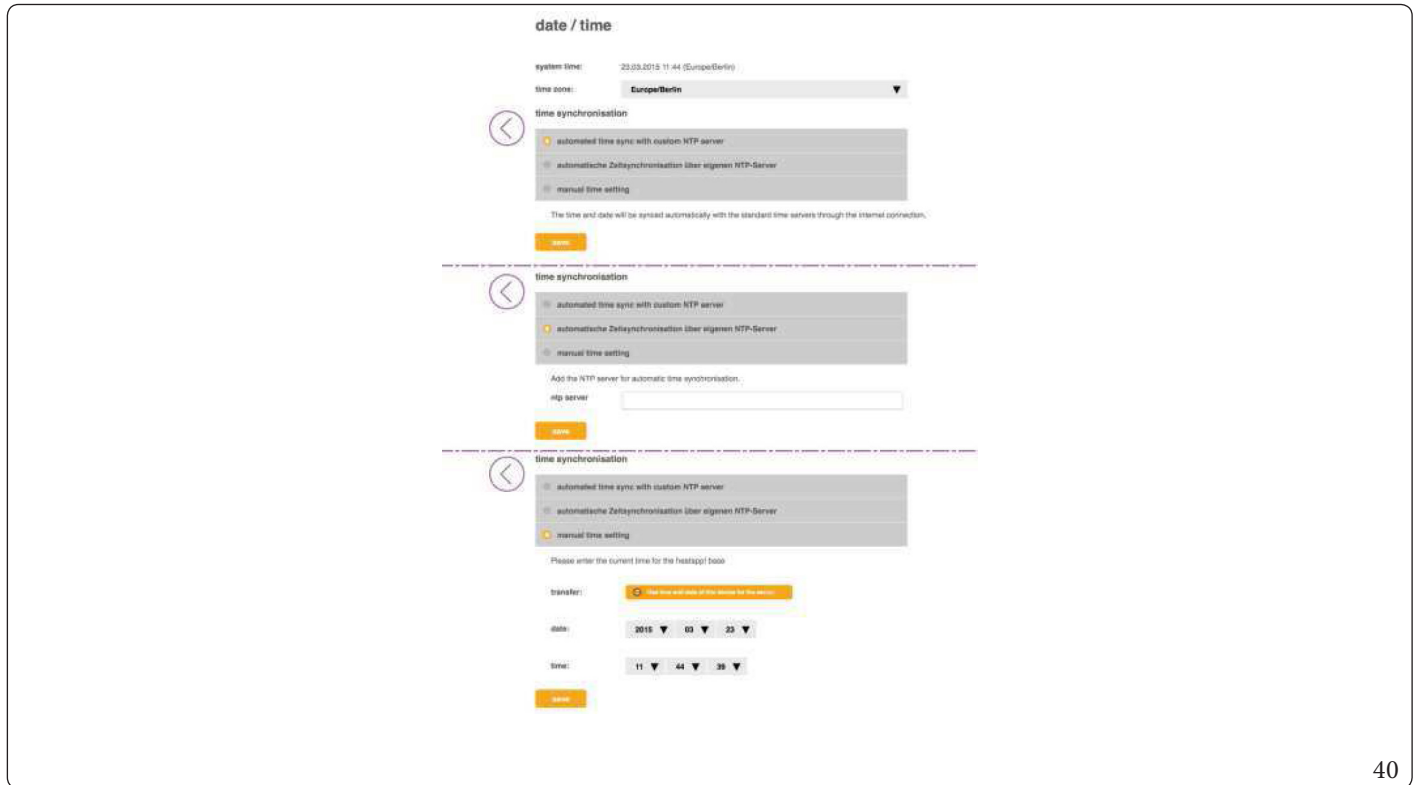

You can make the settings for the real-time clock in the "Date / Time" area. For example, this is necessary, if the manual time setting was selected (summer / winter time).

You can select between the following variants:

- Time synchronisation via the Internet;
- Time synchronisation via an internal NTP server;
- Manual time setting.

Tap on "Save" to apply the settings.

Use the button  to return to the "System" menu.

7.7 SETUP WIZARD

The "Setup wizard" menu item relaunches the setup wizard. This may be for example be due to a move and changed connection to the boiler.

See also section 6.2 "Initial operation using the setup wizard".

7.8 SYSTEM MANAGEMENT

In the "System management" area, you can update the heatcon! system software and perform a data backup.



For the "monitor" e "System data backup" functions, use an empty, FAT32 (Linux) formatted USB stick with a maximum size of 32 GB.

Updating the system software

EbV works constantly to improve the **heatcon!** system. To ensure our customers can benefit from this, we have developed an update system, which means you are always offered the latest version.

You decide whether you want to install the offered update or would prefer to retain the existing version. A display appears below the current software indicating whether a software update is available.



Software updates are only displayed, if the **heatcon!** system is connected to the Internet.

When updating the device software by downloading via the Internet additional costs may be charged depending on the customer's actual Internet tariff.



It is not possible to update the MMI 200 via the Internet. An update of the MMI 200 is only necessary in exceptional cases (new functions of the MMI). The update can only be performed by the EbV manufacturer.

The "Restart system now" button triggers a restart.



A restart of the **heatcon! system** deletes the stored data of the "Live View". If the USB data backup of the monitor is activated, the data on the USB stick will of course be retained and can still be used.

Reset to factory settings

The "reset now" button, resets the device to the factory settings.



Upon resetting, all set data is irrevocably lost and a new setup is necessary. Please only use this option, if expressly Requested to do so by our customer support or your expert.

Monitor

The monitor shows current and historical data of your heating system. If you wish to store the data for more than 24 hours, insert a USB memory stick into the system and activate the storage option.

The system will store the data until the USB memory space runs out. The oldest data will then be overwritten automatically.



- Before removing the USB memory stick from the system, please disable the option to avoid data loss.
- The data will be overwritten automatically without warning. If you want to keep the data permanently, always make sure that there is enough memory on the USB memory stick.

System data backup

You can perform a data backup using a USB stick. Using this back-up system you can transfer the installation to a new device or after re-setting of the system, quickly return to the backed up condition.

1. Insert a USB stick in a USB port of the **heatcon! EC**.
2. Tapping the "ok" button saves a backup file on the USB stick.

Restoring the backed up system data

1. Insert a USB stick with a data backup file in a free USB port of the heatcon! EC system.
2. Select the required backup file.
3. Tapping the "refresh" button transfers the selected backup to the system.

Use the button to return to the "System" menu.

7.9 EXPERT (TECHNICIAN)

The Expert (Technician) menu is divided in different areas and changes depending on the hydraulics and configuration. Information and changeable parameters are available for each area. These differ depending on the selection of the energy generator. A complete parameter list can be found in chapter 8 8 “Parameter description“.

7.10 MONITOR

The monitor shows current and historical data of your heating system.

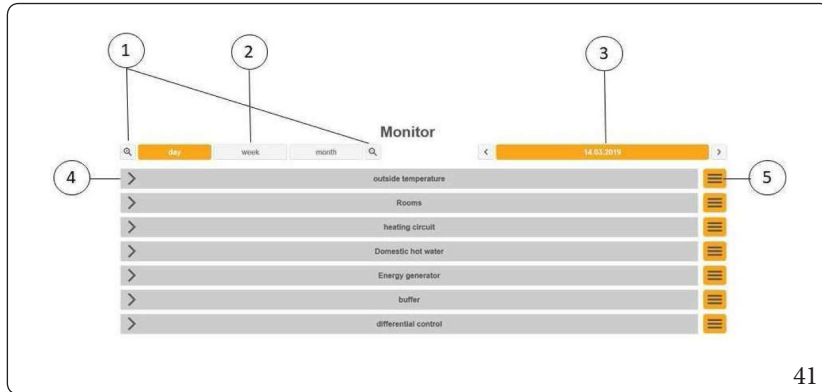

Key (Fig. 41):

- 1 - Zoom in / zoom out the X-axis (horizontal axis)
- 2 - Selection day/week/month
- 3 - Selection date
- 4 - Representation of the individual areas
- 5 - Menu



Tap / click on the arrow (pos. 4, Fig. 41) to open the display of the respective area.

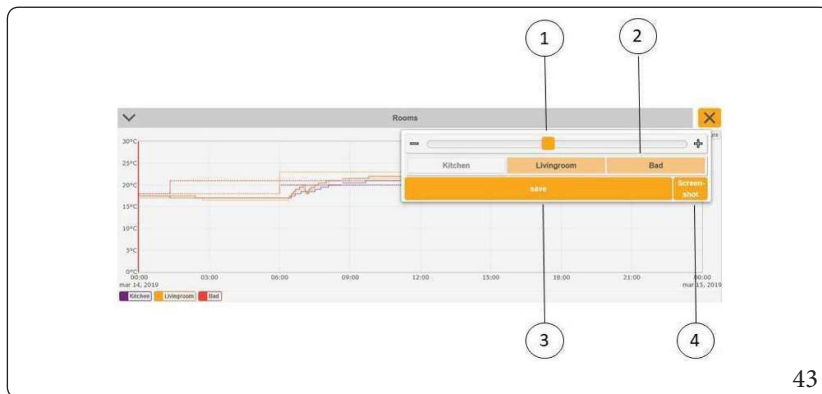

Selection options are available by tapping / clicking on the menu.

Key (Fig. 43):

- 1 - Zoom in / zoom out the Y-axis (vertical axis)
- 2 - Selection of room / heating circuit / sensor and so on
- 3 - Save
- 4 - Create screenshot (only possible on computer / laptop)

All selected areas (outdoor sensors, rooms, heating circuits, etc.) are displayed below the diagram as a legend. Individual areas can be hidden by clicking / tapping. The status is displayed below the diagram. A full bar shows the activity, an empty bar the inactivity of the respective device (heating circuit, Pump, energy generator and so on).



44

The red vertical line moves by double-clicking / tapping on the desired time. This allows the comparison of the individual graphs. This makes it easy, for example, to find out where the Request comes from.

8 PARAMETER DESCRIPTION

This section describes the menus and parameters of the heatcon! system. Depending on the system configuration, not all the menus and parameters are visible.

The heatcon menus and parameters! EC 1351 PRO are accessible via the heatcon! interface MMI 200, via the heatapp! App and WEB Browser.

- The factory setting of the parameters is shown in bold.
- The “Access” column specifies the required access rights for the parameter:
 - **BE**: Operator/owner
 - **HF**: Expert (expert)
 - **OEM**: OEM manufacturer

8.1 CALLING THE EXPERT MENU

8.1.1 Heatcon MMI

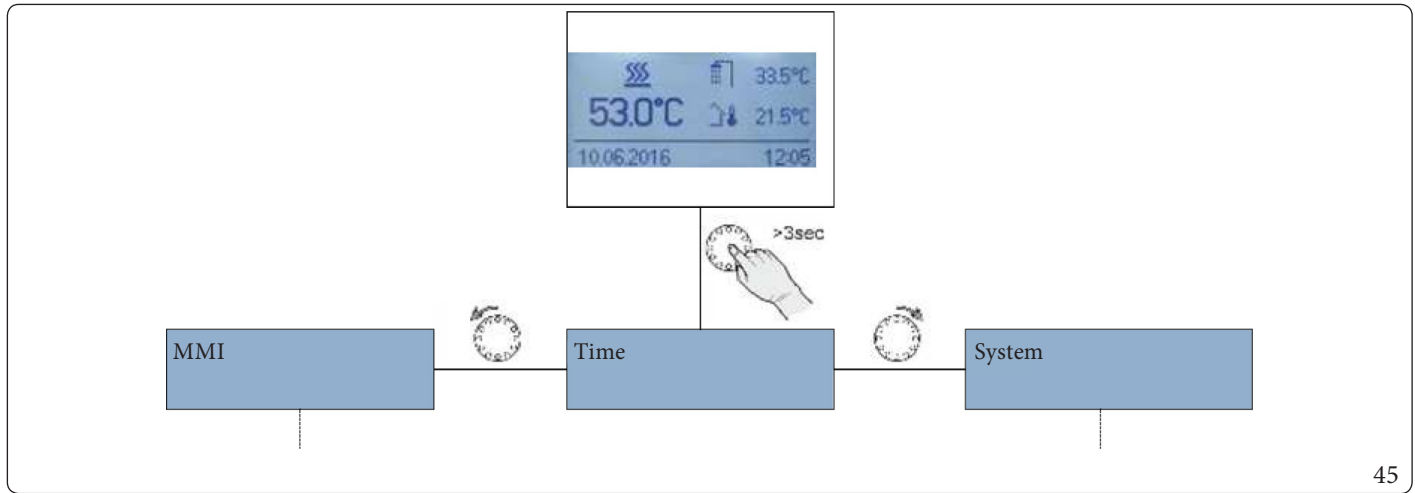

45

8.1.2 heatapp! APP

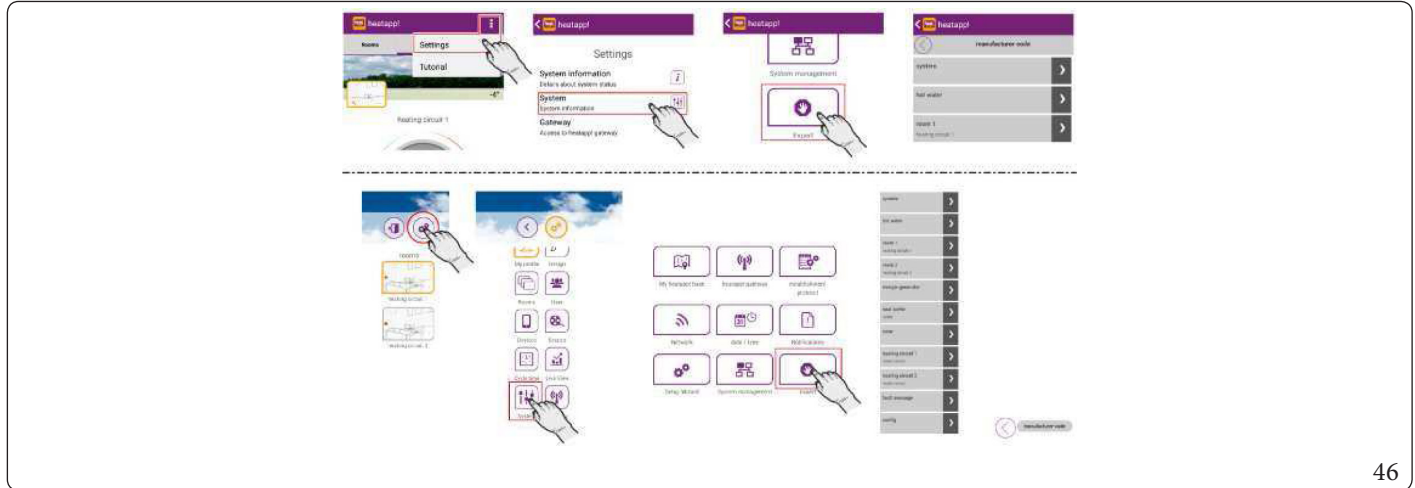

46

i The representation of the heatapp! app (Fig. 45) is a typical one. The representation may differ depending on the MMI device and operating system.

8.1.3 PC user interface

1. Open an WEB browser on your PC.
2. Enter the IP address of the heatcon! EC in the address list of the WEB browser. You can determine the IP address of the heatcon! EC via the heatapp! app in the menu "Settings/System/Network" or via the HMI of your router. The PC user interface opens.
3. Click on the "expert" button to call the Expert Menu.

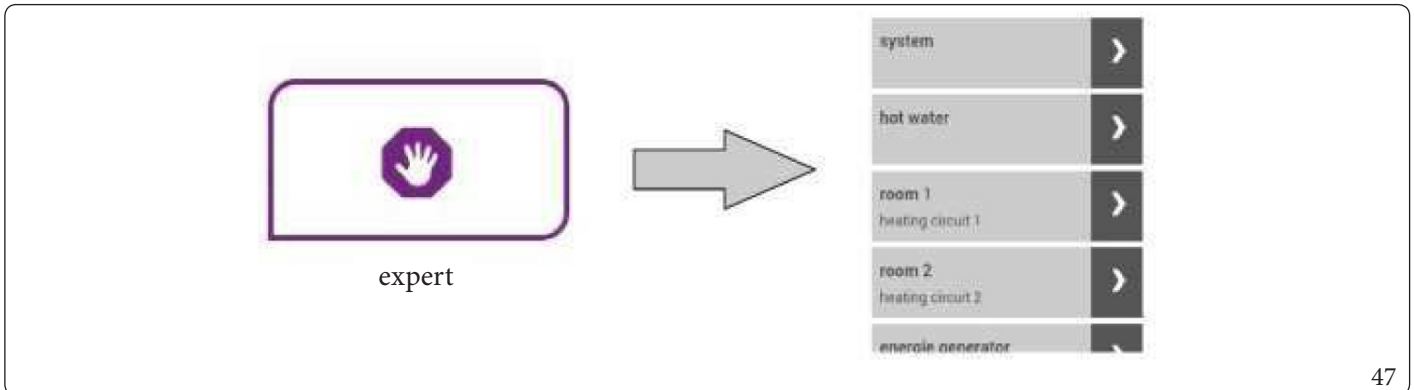

47



The representation of the menu (Fig. 46) is a typical one. The representation may differ depending on the HMI device and operating system.

8.2 HEATCON!MMI

The MMI system menus are described below. The factory setting of the parameters is shown in bold.

Menu/Parameter (Display)	Settingrange	Description	Access
MMI			
Language	DE , GB, FR, IT, NL, PL, ES, TR, RU	MMI language selection German , English, French, Spanish, Turkish, Dutch, Italian, Russian... The language expansions of the heatcon! system are implemented via updates that are made available via the Internet. Therefore the list of languages is not complete.	BE
fahrenheit	off , on	Changeover of the temperature display into Fahrenheit.	BE
display information 1	off, 1...15 (1)	Selection of the temperature values output to the basic display.	BE
display information 2	off, 1...15 (2)		BE
display information 3	off, 1...15 (3)		BE
Access right	0001 ... 9999	Code input for selection of access rights. BE User (0000) HF Expert (1234)	BE
mapping	heatcon! 0... 5	Assignment of heatcon! MMI to the respective heatcon EC.	HF
timeout	off, 0.5... 2 ... 10.0 min	Time setting after which the MMI jumps back to the basic display.	BE
LCD contrast	-10 ... 0 ... 10	Contrast setting for the LCD display on heatcon! MMI.	BE
LCD brightness	0 ... 5 ... 10	Brightness setting of the background lighting for the LCD display on the heatcon! MMI.	BE
MMI	–	Display of the item number of the heatcon! MMI.	HF
version	–	Display of the software version of the heatcon! MMI.	HF
show name	off , on	Activate display of the individual default names. The default names are then displayed highlighted.	HF
reset	off , set	Reset to factory settings based on access rights.	BE/HF

Menu/Parameter (Display)	Settingrange	Description	Access
time			
time	00:00 ... 23:59 hour	Setting of the system time.	BE
year	2013 ... 2099		
month	1 ... 12		
day	1 ... 31		
CEST	off, on	Changeover to summertime.	BE

8.3 MENU – SYSTEM

Menu/Parameter (Display)	Setting range	Description	Access
.../System			
clima zone	Off, -20.0 ... -12,0 ... 0.0 °C	Setting of the coldest anticipated outside temperature value. The value entered is included in the calculation of the Request value.	HF
Building	easy, medium , heavy	Selection of the building type when using outside temperature control.	HF
Emergency mode outside temperature	-50.0 ... 0.0 ... 30.0 °C	Outside temperature setting which is used for control after failure of the outside sensor.	HF
error code machine	off, interlock, locking, warning	Selection of which fault messages of a machine are displayed and processed in the system (e.g. EO).	HF
color symbols	off, on	Activates the visual display “Heating active” in the heatapp! APP.	HF
room setpoint max.	off ... 0, 0 ... 5, 0 K	System-wide limitation of the room Setpoint temperature.	HF
reset	off , set	Resetting of the heatcon! parameters to the factory settings dependent on the access authorisation.	BE/HF

X₃ Display only occurs if at least one heatapp! floor is integrated in the system.

8.4 MENU – ROOM GROUP 1...N



The division into 1-24 rooms is not available since Immergas does not provide the complete heatapp system! (gateways, heads, ...).

Menu/Parameter (Display)	Subparameter (display)	Description
expert/Room 1 ... 24/ information		
expert/room group 1 ... n/ information		
operation mode	Display of the current operation mode.	
	absent	“absent” operation mode/scene active.
	automatic	Operation according to switching time program is active.
	Emission	Emission measurement active.
	screed	Screed drying program active.
	manual mode	Manual mode active.
	Runtime Magic Wand	Manual temperature specification via magic wand function is active.
	Reloading	Room active for an activated hot water reloading (only with single room control).
	Party	“Party” operation mode/scene active.
	standby	“standby” operation mode/scene active, frost protected Room/room group switched off.
	Vacation until	“standby” operation mode/scene active, frost protected Room/room group switched off.
	switch contact	Connected switching contact closed.
state	Display of the current status.	
	anti-lock system	Anti-lock system active for the actuators in the room (only with single room control).
	heating	Regulation to comfort or economy temperature.
	heat limit	Switching off via heating limits function.
	room blocking	Room not active due to exceeding the set limit temperature (only in connection with a room sensor).
	frost protection	Frost-protected room switched off.
	summer operation mode	Room out of operation due to summer economy control.
	off	Room not active (e.g. in automatic mode setback phases).
	Scheduled temperature	Display of the current Setpoint for the room temperature.
	current temperature	Display of the current temperature of the room (only if room temperature measurement is active).
	outside temperature	Display of the current outside temperature that is used for room control.
	outside temperature long-term	Display of the long-term outside temperature value. This value is determined on the basis of the selected building type (System menu).
	request	Display of the actual Setpoint temperature which is forwarded to the supply of the hot water heating (e.g. heating circuit Setpoint taking into account raising values).
	heating circuit 1	Display of the current temperature of the required heating circuit.

INSTALLER

USER

Menu/Parameter (Display)	Setting range	Description	Access
expert/Room 1 ... 24/ timerprograms			
expert/room group 1 ... n/ timerprograms			
Vacation until	DD:MM...DD:MM	Vacation period setting for the room/room group.	BE
mo 1...3 tu 1...3 ... su 1...3	00:00... 24:00 06:00... 22:00	Setting of the switching times for the room/room group.	BE
copy		Allows to copy the daily program from a selected day to another selected day.	

Menu/Parameter (Display)	Setting range	Description	Access
expert/Room 1 ... 24/ basicsettings			
expert/room group 1 ... n/ basicsettings			
request	outside temperature control, room control, constant control	Selezione del fabbisogno per la Room/room group.	HF
screed	off, functional heating, laying heating, functional heating laying heating	Selection of the screed heating program for Room/room group. See also section.	HF
Outside sensor mapping	outside temperature 1 , outside temperature - 2, external probe 1 average value and external probe 2 average value	Selection of the corresponding outside sensor for the Room/room group, if a second outside sensor has been configured.	HF
frost protection	off, -20 ... 3 ... 29 °C (o summer operation mode)	Impostazione della temperatura esterna per l'attivazione della funzione antigelo per la Room/room group.	HF
summer operation mode	off, frost protection ... 20,0 ... 30 °C	Impostazione della temperatura esterna per l'attivazione della modalità di funzionamento estivo per la Room/room group.	HF
room blocking	off , 0,1 ... 5 K	Setting for the room temperature raising value above which a requirement sent to the energy generator is discarded.	HF
Antifreeze mode	frost protection temperature, Set-back temperature	Selection of the temperature level based on which the frost protection function for the room/room group is to be controlled. Room frost protection deviation control based on the set frost protection temperature or room frost protection deviation control based on the set set-back temperature.	HF
Runtime Magic Wand	off, 0,5 ... 3.0 ... 12.0 h		HF
switch contact	off, standby, reduce, central heating, frost protection	Per il settaggio vedi il menù config/function/extras	HF
name	Alphanumeric, maximum of 15 characters, no special characters		BE

Menu/Parameter (Display)	Setting range	Description	Access
expert/Room 1 ... 24/ room settings			
expert/room group 1 ... n/ room settings			
maximum temperature	comfort temperature 28,0°C	Setting the maximum room Setpoint temperature for the room.	BE
comfort temperature	economy temperature... 21.0... 28,0°C	Room Setpoint temperature setting for heating operation.	BE
economy temperature	Setback temperature... 20,0°C ... comfort temperature	Setting of the reduced room Setpoint temperature for heating operation.	BE
Reduction temperature	Antifreeze protection temperature ... 18,0°C ... economy temperature	Room Setpoint temperature setting for setback operation.	BE
Anti-freeze temperature	4.0 ... 16.0°C ... Set-back temperature	Room Setpoint temperature setting for frost protection operation.	BE
Switch on optimation	off , 0,5... 8.0h	Start time advance setting dependent on the outside temperature.	HF
boost offset	0,5 ... 2,0 ... 5,0 K	Increase setting of the room Setpoint temperature if Boost scene is activated in the heatapp! app.	BE

Menu/Parameter (Display)	Setting range	Description	Access
expert/Room 1 ... 24/ heating mode			
expert/room group 1 ... n/ heating mode			
set-back mode	standby, heating	Selection of the operation mode for setback operation. Frost protected switch-off (standby) or set set-back temperature (heating).	BE
room factor	off , 5 ... 100 ... 500 %	Room factor setting (room temperature influence).	HF
Frost protection cycle	off , 0,5 ... 360,0 Min	Selection of the operation mode for the frost protection function for the room/room group. Off: Permanent system frost protection, Time: Cycle time of the system frost protection.	HF
heating curve	off , 0,5 ... 3,5	Steepness setting of the heating curve with outside temperature control.	BE
Heating system	1,0 ... 10,0	Standard values for setting: Underfloor heating system: 1.10; Radiator: 1,30; Convactor: 1.40; Air conditioning >2.00.	HF
adaption	off , on	Activation of the automatic parameter adaptation for the heating curve.	HF
heat limit	off , 0,5 ... 40 K	Heat limit setting for the room.	HF
increase of request	-5,0 ... 0,0 ... 20 K	Requirement-boost setting for the room. Increase to the Setpoint for passing on to the heating circuit.	HF

INSTALLER

USER

Menu/Parameter (Display)	Setting range	Description	Access
expert/Room 1 ... 24/ screed			
expert/room group 1 ... n/ screed			
Temperature day 1... 30	15.0°C... 65.0°C	Setting the temperature for the manual screed function. The preset temperature values are identical to the function "Functional and laying heating". By entering a temperature value for day 26, the menu expands to day 27, etc.	HF

Menu/Parameter (Display)	Setting range	Description	Access
expert/Room 1 ... 24/ reset			
expert/room group 1 ... n/ reset			
reset	off, set	Resetting of the parameters in the "Room group/heating circuit" menu to factory presets, dependent on access rights.	BE / HF

8.5 MENU – HEATING CIRCUIT 1 ... N

Menu/Parameter (Display)	Subparameter (display)	Description
expert/heating circuit/ information		
expert/heating circuit 1 ... n/ information		
state	anti-lock system	Anti-lock system for the actuators.
	heating	Control to comfort or economy temperature.
	priority	Heating circuit is switched off by DHW priority.
	heat limit	Switch-off via functional heating limit.
	frost protection	Heating circuit switched off frost-protected.
	summer operation mode	Heating circuit out of operation due to summer switch-off.
	off	Heating circuit not active (e.g. in setback phases automatic mode).
Setpoint	Display of the current Setpoint of the heating circuit.	
current temperature	Display of the current heating circuit flow temperature (mixed heating circuit only).	
pump	State of heating circuit Pump On/Off.	
mixing valve	Calculated position of the actuator.	
request	Display of the current Setpoint temperature which is passed on for supply (e.g. heating circuit Setpoint taking into account excessive values).	
Energy generator	Display of the actual temperature GEN at supply to the energy generator.	

Menu/Parameter (Display)	Setting range	Description	Access
expert/heating circuit/ basic settings			
expert/heating circuit 1 ... n/ basic settings			
name	Alphanumeric, maximum of 15 characters, no special characters.	Entry of the name for the heating circuit.	HF

INSTALLER

USER

Menu/Parameter (Display)	Setting range	Description	Access
expert/heating circuit/heating mode			
expert/heating circuit 1 ... n/heating mode			
minimum temperature	off, 10 ... 20°C ... minimum temperature	Minimum temperature limit.	HF
maximum temperature	off, minimum tempera- ture ... 45°C ... 95°C	Maximum temperature limit.	HF
increase of request	-5,0 ... 0,0 ... 20 K	Setting of the increase of request to the setpoint for transfer to the energy supplier (GEN or buffer).	HF
Return flow limitation	off, 10 ... 95°C	Limitation value for configured return flow limitation.	HF

Menu/Parameter (Display)	Setting range	Description	Access
expert/heating circuit/pump			
lead time	off, 0,5 ... 360 Min	Setting the lead time of the heating circuit Pump.	HF
Overrun time	off, 0,5 ... 360 Min	Setting the run-after time of the heating circuit Pump.	HF
anti-lock system	off, 5 ... 20 ... 300 Sec	Setting the running time for the anti-lock protection of the heating circuit Pump.	HF
switch on mode	Constant mode, Temperature diffusion, setpoint	Selection of the operation mode for the speed control of the heating circuit Pump.	HF
interrupting voltage	off, 0,1 ... 10 V	Setting of the interruption voltage of the heating circuit Pump.	HF
start time	off, 1 ... 10 ... 240 Sec	Setting the start time of the heating circuit Pump.	HF
start output	0 ... 100 %	Setting the starting output of the heating circuit Pump.	HF
output	1 ... 100 %	Setting the output of the heating circuit Pump (with switch-on mode constant operation).	HF
minimum voltage	0,0 ... 5,0 ... 10 V	Setting of the minimum voltage of the heating circuit Pump.	HF
minimum output	0 ... 50 ... 100 %	Setting of the minimum output of the heating circuit Pump.	HF
maximum voltage	0,0 ... 10 V	Setting of the maximum voltage of the heating circuit Pump.	HF
maximum output	0 ... 100 %	Setting of the maximum output of the heating circuit Pump.	HF
regulation gain	1,0 ... 2,0 ... 50 %/K	Setting the gain of the PID controller for the heating circuit Pump.	HF
regulation adjust time	1 ... 270 ... 600 Sec	Setting the adjust time of the PID controller for the heating circuit Pump.	HF
regulation scan time	1 ... 20 ... 600 Sec	Setting the scanning time of the PID controller for the heating circuit Pump.	HF
temperature spread	2,0 ... 10,0 ... 20,0 K	Setting of the temperature spread for the "Temperature spread" switch-on mode.	HF

Menu/Parameter (Display)	Setting range	Description	Access
expert/heating circuit/ mixing valve			
expert/heating circuit 1 ... n/ mixing valve			
regulation gain	1,0 ... 2,0 ... 50%/K	Setting the gain of the PID controller for the heating circuit Pump.	HF
regulation adjust time	1 ... 270 ... 600 Sec	Setting the adjust time of the PID controller for the heating circuit Pump.	HF
regulation scan time	1 ... 20 ... 600 Sec	Setting the scanning time of the PID controller for the heating circuit Pump.	HF
runtime	1 ... 120 ... 600 Sec	Actuator running time.	HF
stop position deactivation	off , on	Valve stop position control.	HF
anti-locksystem	off, 1 ... 20 ... 300 Sec	Setting the running time for the anti-lock protection of the mixing valve.	HF

Menu/Parameter (Display)	Setting range	Description	Access
expert/heating circuit/ heat balance			
volume flow	off , 0,5 ... 300 L/Min or L/pulse	Setting the flow rate for heat balancing or setting the unit for the pulse input of a flow meter.	HF
medium density	0,8 ... 1,05 ... 1,2 kg/L	Setting the density of the heat transfer medium for heat balancing.	HF
medium heat capacity	1,0 ... 3,6 ... 50 kJ/kg*K	Setting the heat capacity of the heat transfer medium for heat balancing.	HF
reset	off , set	Resetting the meter for heat balancing.	HF

Menu/Parameter (Display)	Setting range	Description	Access
expert/heating circuit/ reset			
reset	off , set	Reset the parameters in the menu "heating circuit" to factory settings according to the access authorization.	HF

8.6 MENU – HOT WATER (1) (2)

Menu/Parameter (Display)	Subparameter (display)	Description
expert / hot water / information		
operation mode		Display of the current operation mode.
	Emission	Emission measurement program active.
	manual mode	System in manual mode.
	Vacation until	Vacation program active.
	Reloading	Manual hot water reloading active.
	automatic	Operation according to switching time program is active.
	standby	Frost protection is switched off.
	switch contact	Connected switching contact closed.
state		Display of the current status.
	Emission	Emission measurement program active.
	manual mode	System in manual mode.
	Forced draining	Active due to a forced draining function.
	setpoint	Setpoint is reached.
	heating	Hot water charging with Setpoint active.
	Blocking	Hot water charging is blocked.
	Setpoint reduction	Hot water Setpoint is reduced by differential control.
	overrun time	Overrun time time active.
	lead time	Pump lead time active.
	stop	Discharge protection or boiler start-up protection active or advance operation of a second hot water tank.
Scheduled temperature		Display of the current Setpoint for hot water heating.
current temperature (1)		Display of the current temperature of the hot water storage.
current temperature (2)		Display of the current temperature of the second hot water in stratified charge.
pump		Display of the current status of the DHW storage charging Pump.
request		Display of the actual Setpoint temperature which is forwarded to the supply of the hot water heating (e.g. buffer Setpoint or energy generator Setpoint taking into account raising values).
Energy generator		Display of the flow temperature of the boiler connected via EEZ-BUS (of the boiler with the lowest address).
current temperature xx		Display of the actual temperature of the Requested source (heating buffer, energy generator).
circulation pump		Display of the operating status of the recirculation pump.
heating usage		Display of the current status for the Heating usage (only with the Heating usage optional function).
setpoint		Display of the current Setpoint, which is used for controlling the Heating usage (only with the Heating usage optional function).
current temperature		Display of the actual temperature for the Heating usage (only with the Heating usage optional function).
DHW circulation pump		Display of the current status of the DHW circulation pump (only with the optional DHW circulation pump function)
Scheduled temperature		Setpoint from which the DHW circulation pump is switched on (only with the DHW circulation pump optional function).
current temperature (1)		Display of the current temperature of the DHW circulation pump sensor (only with the DHW circulation pump optional function).
current temperature (2)		Display of the current temperature of the second sensor of the DHW circulation pump (only with the DHW circulation pump optional function).
thermal output		Display of the current heating output in kW.
heat quantity		Display of the meter reading of the heat meter for the hot water storage in kWh.

Menu/Parameter (Display)	Setting range	Description	Access
expert/hot water/timerprograms			
Vacation until	DD:MM DD:MM	Setting of the vacation period for hot water heating.	BE
mo 1...3 tu 1...3 ... su 1...3	00:00 ... 24:00	Setting of the switching times for the room/room group.	BE
copy		Allows to copy the daily program from a selected day to another selected day.	

Menu/Parameter (Display)	Setting range	Description	Access
expert/hot water/basicsettings			
operation mode	parallel, Air-conditioning priority, Weather parallel operation, Priority with intermittent central heating	Selection of the operation mode for hot water heating.	HF
Reloading	off , 5 ... 240 min	Selection of the reloading time for hot water heating. Charging of hot water storage is activated for the set time.	BE
shutdown	Room, operation mode	Selection, whether to switch off hot water heating based on the room setting or be setting the hot water operation mode.	HF
switch contact	off, standby, reduce, central heating, frost protection	Selecting the property of the switching contact function (only if a switching contact input has been selected in the "extras" menu).	HF
name	Alphanumeric, maximum of 15 characters, no special characters	Entry of the name for the hot water function.	HF

Menu/Parameter (Display)	Setting range	Description	Access
expert/hot water/heating mode			
day setpoint	night setpoint (+0.5K) ...50.0°C... maximum temperature	Setting of the hot water setpoint temperature for heating operation.	BE
night setpoint	5.5... 40.0°C ... day setpoint (-0.5K)	Setting of the hot water setpoint temperature for reduce mode.	BE
switching difference	-30.0...- 2.5K ...30.0	Switching difference setting for hot water storage charging. Start charging. If actual temperature < setpoint - switching difference.	HF
hysteresis	1.0... 5.0K ...30.0	Hysteresis setting for hot water storage charging. End charging: If actual temperature > setpoint - switching difference + hysteresis.	HF
maximum temperature	20.0... 60.0°C ...80.0	Maximum temperature setting for the hot water storage.	HF
increase of request	0.0... 20.0K ... 50.0	Raising setting for forwarding the requirement to the energy source.	HF
discharge protection	off , On	With discharge protection activated and a DHW request present, the DHW loading pump is only enabled when the temperature in the energy generator rises by more than 5 K above the actual temperature in the hot water storage.	HF
legionella protection day	off , mo...su, all	Selection of the day for legionella protection.	BE
legionella protection time	hours 00:00...2:00 ...23:50	Time setting for legionella protection.	BE
legionella protection	20,0...60.0°C... maximum temperature	Temperature setting for legionella protection.	HF
Legionella protection charging duration	off , 5 ... 60 min ... 240	Charging duration setting for legionella protection.	HF

Menu/Parameter (Display)	Setting range	Description	Access
expert / hot water / pump			
lead time	off , 0,5 ... 360 Min	Lead time setting of the charging Pump.	HF
Overrun time	off , 0,5 ... 360 Min	Overrun time setting of the charging Pump.	HF
anti-lock system	off , 5 ... 20 ... 300 sec	Runtime setting for the anti-lock protection of the charging Pump.	HF
switch on mode	Constant operation , temperature spread, setpoint	Operation mode selection for speed-control of the charging Pump.	HF
Voltage break	off , 0,1 ... 10 V	Cut-off voltage setting of the charging Pump.	HF
start time	off , 1 ... 10 ... 240 sec	Start time setting of the charging Pump.	HF
start output	0 ... 100 %	Starting capacity setting of the charging Pump.	HF
output	1 ... 100 %	Capacity setting of the charging Pump.	HF
minimum voltage	0,0 ... 5,0 ... 10 V	Minimum voltage setting of the charging Pump.	HF
minimum output	0 ... 50 ... 100 %	Minimum capacity setting of the charging Pump.	HF
maximum voltage	0,0 ... 10 V	Maximum voltage setting of the charging Pump.	HF
maximum output	0 ... 100 %	Maximum capacity setting of the charging Pump.	HF
regulation gain	1,0 ... b2,0 ... 50 %/K	Gain setting of the PID controller for the charging Pump.	HF
regulation adjust time	1 ... 270 ... 600 sec	Reset time setting of the PID controller for the charging Pump.	HF
regulation scan time	1 ... 20 ... 600 sec	Sample time setting of the PID controller for the charging Pump.	HF
temperature spread	2,0 ... 10,0 ... 20.0 K	Temperature spread setting for the "Temperature spread" switch-on type.	HF

Menu/Parameter (Display)	Setting range	Description	Access
expert / hot water / heating usage			
summer operation mode	off , -20,0 ... 30.0 °C	Outside temperature setting from which Heating usage activation should take place.	HF
setpoint raise	-20,0 ... 0,0 ... 20.0 K	Setting for matching the hot water Setpoint with an active Heating usage.	HF

Menu/Parameter (Display)	Setting range	Description	Access
expert/hot water/circulation pump			
mode	off, time , time e temperature	Selection of the operation mode for the DHW circulation pump.	HF
Period time	(break time + 0.5) ... 15,0 ... 360 Min	Setting of the operating duration of the DHW circulation pump in the operation mode "time/time and temperature".	HF
break time	off, 0.0 ... 5.0 ... (Period time - 0.5 min)	Setting of the Break duration of the DHW circulation pump in the operation mode "time/time and temperature".	HF
Setpoint	5,0 ... 35,0 ... 80.0 °C	Setting of the switch on temperature of the circulation pump in the operation mode "temperature/time and temperature" if only one sensor has been configured.	HF
hysteresis	1,0 ... 5,0 ... 10.0 K	Setting of the temperature hysteresis of the circulation pump in the operation mode "temperature/time and temperature" if two sensors have been configured.	HF
switching difference	1,0 ... 5,0 ... 30.0 K	Setting of the temperature Switch-off difference of the DHW circulation pump in the operation mode "temperature/time and temperature" if one or two sensors have been configured.	HF
anti-lock system	off , 5 ... 20 ... 300 sec	Interval setting for the anti-lock protection of the DHW circulation pump.	HF

Menu/Parameter (Display)	Setting range	Description	Access
expert/hot water/heat balance			
volume flow	off , 0,5 ... 300 L/min o L/impuls	Setting of the volume flow for heat consumption measurement or setting of the units for pulse input of a flow meter.	HF
medium density	0.8 ... 1,05 ... 1.2 kg/L	Density setting of the heat transfer medium for heat consumption measurement.	HF
medium heat capacity	1.0 ... 3,6 ... 50 kJ/kg*K	Heat capacity setting of the heat transfer medium for heat consumption measurement.	HF
reset	off , set	Resetting of the meter for heat consumption measurement.	HF

Menu/Parameter (Display)	Setting range	Description	Access
expert/hot water/reset			
reset	off , set	Resetting of the parameters in the "hot water" menu to factory presets, dependent on access rights.	BE/HF

8.7 MENU – HEATING BUFFER (1) (2)

Menu/Parameter (Display)	Subparameter (display)	Description
... / Heating buffer / information		
state		Display of the current status.
	Absorption	Absorption function active.
	start protection	Charging Pump is blocked by the GEN minimum temperature.
	off	Charging switched off.
	Blocking	Blocking active.
	Blocking	Buffer charging blocked until GEN actual \geq heating buffer target +5K.
	on	Charging switched on.
	frost protection	Frost protection function active.
	manual mode	Manual mode active.
	Maximum limit	Overtemperature in the heating buffer.
	Setpoint reduction	Setpoint reduction by differential control.
Forced draining	Forced draining active.	
Setpoint	Display of the current Setpoint for the heating buffer.	
current temperature (1)	Display of the current temperature BS1 (buffer top).	
current temperature (2)	Display of the current temperature BS2 (buffer bottom).	
pump	Display of the current status of the buffer load Pump or the buffer switching valve.	
Request contact	Status display of the external Request contact of the buffer storage (option).	
Buffer hydraulic drain	Status display of the hydraulic buffer discharge.	
request	Display of the current Setpoint temperature which is forwarded for supply of the heating buffer.	
current temperature	Display of the actual temperature of the energy generator.	
Energy generator	Display of the flow temperature of the boiler connected via EEZ-BUS (of the boiler with the lowest address).	

INSTALLER

USER

Menu/Parameter (Display)	Setting range	Description	Access
.../Heating buffer /basic settings			
Commutation difference	1,0 ... 5,0K ... 70,0	Switching difference setting for buffer charging. Start charging: If actual temperature < Setpoint - switching difference.	HF
minimum temperature	5 ... 20,0°C ... 110,0	Minimum temperature setting for the heating buffer.	HF
maximum temperature	5 ... 75,0°C ... 110,0	Maximum temperature setting for the heating buffer.	HF
increase of request	-5,0 ... 10,0K ... 80,0	Raising setting for forwarding the requirement to the energy source.	HF
Drain protection	off, on	Activation of the discharge protection function for the heating buffer.	HF
Forced draining	5,0 ... 95.0 110.0°C	Temperature setting for forced draining activation.	HF
constant temperature	off , 7,0 110.0°C	Heating buffer temperature setting with an activated external Request contact.	HF
Absorption	off , 10,0 ... 100.0°C	Temperature setting for activation of the absorption function.	HF
Switch on difference	0 ... 10,0K ... 100,0	Switch on difference setting if the absorption function is activated.	HF
Switch-off difference	0 ... 5,0K ... 50,0	Switch-off difference with the absorption function activated.	HF
start protection	off , 5,0 ... 30,0 ... 85,0°C	Temperature setting for start-up protection.	HF
name	Alphanumeric, maximum of 15 characters, no special characters.	Entry of the name for the heating buffer.	HF

Menu/Parameter (Display)	Setting range	Description	Access
.../Heatingbuffer /buffer load pump			
overrun time	off, 0,5 ... 360 Min	Overrun time setting of the charging Pump.	HF
anti-locksystem	off, 5 ... 20 ... 300 sec	Runtime setting for the anti-lock protection of the charging Pump.	HF
switch on mode	Constant operation, temperature diffusion, setpoint	Operation mode selection for control of the charging Pump.	HF
Voltage break	off, 0,1 ... 10 V	Cut-off voltage setting of the charging Pump.	HF
start time	off, 1 ... 10 ... 240 sec	Start time setting of the charging Pump.	HF
start output	0 ... 100 %	Starting capacity setting of the charging Pump.	HF
output	1 ... 100 %	Capacity setting of the charging Pump.	HF
minimum voltage	0,0 ... 5,0 ... 10 V	Minimum voltage setting of the charging Pump.	HF
minimum output	0 ... 50 ... 100 %	Minimum capacity setting of the charging Pump.	HF
maximum voltage	0,0 ... 10 V	Maximum voltage setting of the charging Pump.	HF
maximum output	0 ... 100 %	Maximum capacity setting of the charging Pump.	HF
regulation gain	1,0 ... 2,0 ... 50 %/K	Gain setting of the PI controller for the charging Pump.	HF
regulation adjust time	1 ... 270 ... 600 sec	Reset time setting of the PI controller for the charging Pump.	HF
regulation scan time	1 ... 20 ... 600 sec	Sample time setting of the PI controller for the charging Pump.	HF
temperature spread	2,0 ... 10,0 ... 20,0 K	Temperature spread setting for the "Temperature spread" switch-on type.	HF

Menu/Parameter (Display)	Setting range	Description	Access
.../Heatingbuffer /reset			
reset	off, set	Resetting of the parameters in the "Heatingbuffer" menu to factory presets, dependent on access rights.	HF

8.8 MENU – TOTAL FLOW

Menu/Parameter (Display)	Description
expert / total flow / information	
state	Display of the current state.
Setpoint	Display of the setpoint total flow
current temperature	Display of the current actual value of the total flow temperature
request	Request PI control
mixing valve	Calculated position of the actuator
Setpoint temperature	Setpoint temperature valve
current temperature	Current temperature valve
energy generator	Display of the flow temperature of the boiler connected via EEZ-BUS (of the boiler with the lowest address).

Menu/Parameter (Display)	Settingrange	Description	Access
expert / total flow / setpoint			
mode	all, heating circuit, hot water, temp., Cool.	Operating mode	HF
regulation gain	1,0 ... 2,0 ... 50 %/K	Setting of the gain of the PID controller for the total flow control	HF
regulation adjust time	1 ... 270 ... 600 sec	Setting of the adjust time of the PID controller for the total flow control.	HF
regulation scan time	1 ... 20 ... 600 sec	Setting of the scan time of the PID controller for the total flow control.	HF
minimum temperature	5 ... 20 ... 95°C	Minimum temperature	HF
maximum temperature	5 ... 80 ... 95°C	Maximum temperature	HF

Menu/Parameter (Display)	Settingrange	Description	Access
expert / total flow / mixing valve			
regulation gain	1,0 ... 2,0 ... 50 %/K	Setting the gain of the PID controller for the mixing valve.	HF
regulation adjust time	1 ... 270 ... 600 sec	Setting the adjust time of the PID controller for the mixing valve.	HF
regulation scan time	1 ... 20 ... 600 sec	Setting the scan time of the PID controller for the mixing valve.	HF
runtime	1 ... 120 ... 600 sec	Running time actuator	HF
stop position deactivation	off, on	Valve end position control	HF
anti-lock system	off, 1 ... 20 ... 300 sec	Setting the running time for the anti-blocking protection of the mixing valve	HF

Menu/Parameter (Display)	Settingrange	Description	Access
expert / total flow / reset			
reset	off, Run	Resetting the parameters in the "total flow" menu to the factory setting according to the access authorisation	BE/HF

8.9 MENU - CASCADE

Menu/Parameter (Display)	Description	
expert / Cascade / information		
heating mode	Setpoint heating circuit.	
hot water mode	Setpoint hot water circuit.	
current temperature	Temperature value of the control stage or total flow.	
Boiler/s information	Current Operation mode:	
	n	Number of position in cascade manager.
	EC n	EC number of the energy generator.
	GEN n	GEN number of the energy generator.
	x°C	Current Setpoint temperature.
	OFF	No Request.
	OFF	Level is locked.
	HZ	Heating mode.
	WW	Hot water mode.
	KU	Cooling mode.
	(n)	Priority level locked.
	:	No Request.
	=	Management level.
	>	Baseload.
	<	Minimum temperature.
	-	Emission mode.
	#	Manual mode.
	x°C	Current temperature.
	*	Burner state (flame).
	%	Output limit active.
	Err	Boiler fault

Menu/Parameter (Display)	Setting range	Description	Access
expert / Cascade / basic settings			
Control level	Level 1...n (available)		HF
Control level changeover	off 1h ... 720h	Advancing the control stage.	HF

Menu/Parameter (Display)	Setting range	Description	Access
expert / Cascade / reset			
reset	off, set	Reset the parameters in the menu "reset to factory settings according to the access authorization.	HF

INSTALLER

USER

8.10 MENU – ENERGY GENERATOR

Menu/Parameter (Display)	Subparameter (display)	Description
expert / total flow / Energy generator		
state	Display of the current status of the energy generator (GEN).	
	heating	GEN serves Request for heating operation.
	heating	GEN serves Request for hot water operation.
	Emission	GEN emission measurement active.
	SLT	Safety temperature limiter (SLT) triggered.
	manual mode	GEN manual mode active.
	frost protection	GEN serves Request for frost protection function.
	Blocking	GEN blocked by blocking contact.
	overrun time	GEN overrun time time active.
	start protection	GEN start-up protection active.
	outside temperature barrier	Summer or winter block active.
	off	GEN switched off
level	Display of the current status of the energy generator (GEN).	
	on	GEN active.
	off	GEN not active.
	xx%	Display of the actual output with a modulating GEN.
	outside temperature	Outside temperature block active for GEN.
Heat prog.	Display of the current Setpoint for the energy generator.	
Adr0 setpoint	Information of the boiler(s) connected via EEZ-BUS	
Adr0 flow		
Adr0 return		
Adr0 modulation		
Adr0 exhaust gas		
Adr0 water pr.		
Adr1 setpoint		
Adr1 flow		
Adr1 return		
Adr1 modulation		
Adr1 exhaust gas		
Adr1 water pr.		
Adr2 setpoint		
Adr2 flow		
Adr2 return		
Adr2 modulation		
Adr2 exhaust gas		
Adr2 water pr.		
current temperature (1)	Display of the actual temperature of the energy generator.	
current temperature (2)	Display of the current temperature of the energy generator at the second sensor.	
Exhaust gas sensor	Display of the current flue gas temperature.	
pump	Display of the current status of the Pump in the energy generator (e.g. boiler Pump)	
burner starts	Display of the number of burner starts.	
Burner runtime	Display of the burner runtime.	
thermal output	Display of the current heating output of the energy generator.	
heat quantity	Actual meter value of the energy generator heat meter.	

Menu/Parameter (Display)	Setting range	Description	Access
expert / Energy generator / service			
manual mode	off, minimum temperature, maximum temperature	Activation of manual mode for the energy generator.	BE
Meter reset	off, set	Resetting of the energy generator meter (burner starts, burner runtime, heat quantity).	BE/HF

Menu/Parameter (Display)	Setting range	Description	Access
expert / Energy generator / basic settings			
Forced draining	off, hot water, heating circuit, heating buffer, external	Selection of the type of forced draining for the energy generator.	HF
Forced draining	5,0 ... 95,0 110,0 °C	Temperature setting for forced draining activation.	HF
base load exaggeration	0,0 ... 5,0 ... 60 Kase	The current GEN setpoint is increased by the set value of the base load exaggeration.	HF
Switching output	off, 5% ... 100%	Setting the limiting power of the single generator of a cascade.	HF
start protection	off, 5,0 ... 30,0 ... 85,0 °C	Temperature setting for start-up protection.	HF
switching difference	2,0 ... 5,0 ... 20 K	Switching difference setting for the energy generator.	HF
minimum runtime	off, 0,5 ... 2,0 ... 360 Min	Minimum runtime setting for the energy generator per start.	HF
maximum runtime	off, 0,5 ... 360 Min	Maximum runtime setting for the energy generator per start.	HF
switch-off time	off, 0,5 ... 360 Min	Break time setting for the energy generator between two starts.	HF
exhaust gas control	off, 50,0 500,0 °C	Temperature setting for exhaust gas control. If the set temperature is exceeded, the energy generator is blocked dependent on the "Blocking time" parameter or the safety temperature limiter (SLT) is triggered.	HF
Blocktime	off, 5 ... 60 Min, SLT	Setting of the blocking time by triggering exhaust gas control or SLT function selection.	HF
Summer lock	off, (blocco invernale + 1 K) 30,0 °C	Temperature setting for the summer block. If the outside temperature exceeds the set summer block, the energy generator is blocked (HP-bivalence point).	HF

Menu/Parameter (Display)	Setting range	Description	Access
expert/Energy generator / basic settings			
winterlock	off, -20.0°C...(Summer lock - 1 K)	Temperature setting for the winter block. If the outside temperature exceeds the set winter block, the energy generator is blocked (HP-bivalence point).	HF
fault release	off, on	Activation of fault release. If an outside sensor is faulty, an activated summer or winter block is cleared.	HF
full load shutdown	off, 0,5 ... 10 min.	Minimum load control (OpenTherm). Blocking of the GEN for the set time.	HF
heating mode	off, high priority, medium priority, low priority	Priority selection in cascade operation.	HF
Hot water func.	off, high priority, medium priority, low priority	Priority selection in cascade operation.	HF
mode	Normal operation emergency mode	If there is more than one GEN, one GEN stage can be activated as an emergency boiler.	HF
shutdown	minimum temperature , request	GEN Shutdown performance when Request is cancelled.	HF
Start detection	off, 1...360min.	If the GEN minimum temperature is not reached within this time, the "emergency mode boiler" is enabled. Error code 50-3.	HF
name	Alphanumeric, maximum of 15 characters, no special characters	Entry of the name for the energy generator.	HF

Menu/Parameter (Display)	Setting range	Description	Access
expert/Energy generator / heating			
switch-on delay	off, 0,5 ... 360 Min	Setting of the switch-on and switch-off delay for the second stage of the energy generator.	HF
Disconnection delay			
minimum temperature	5.0 ... 38.0°C ...maximum temperature	Minimum temperature setting of the energy generator.	HF
maximum temperature	minimum temperature ... 80,0°C ... 95	Maximum temperature setting of the energy generator.	HF
Output limit	10% ... 100%	Setting the maximum output of the boiler(s) in the heating phase.	HF

Menu/Parameter (Display)	Setting range	Description	Access
expert / Energy generator / hot water			
switch-on delay	off , 0,5 ... 360 Min	Setting of the switch-on and switch-off delay for the second stage of the energy generator.	HF
Disconnection delay			
minimum temperature	5.0 ... 38.0 °C ... maximum temperature	Minimum temperature setting of the energy generator.	HF
maximum temperature	minimum temperature ... 80,0 °C ... 95	Maximum temperature setting of the energy generator.	HF
Output limit	10% ... 100%	Setting the maximum output of the boiler(s) in the DHW phase.	HF

Menu/Parameter (Display)	Setting range	Description	Access
expert / Energy generator 1 o 2 / heat balance			
volume flow	off , 1 ... 300 L/min o L/impulso	Setting of the volume flow for heat consumption measurement or setting of the units for pulse input of a flow meter.	HF
medium density	0,8 ... 1.05 1.2 kg/L	Density setting of the heat transfer medium for heat consumption measurement.	HF
medium heat capacity	1,0 ... 3,6 ... 50 kJ/kg*K	Heat capacity setting of the heat transfer medium for heat consumption measurement.	HF
output 1	off , 1.0 100.0 kW	Thermal power (thermal output) setting of the energy generator stages. The heat quantity is calculated from the heating output set here and the runtime.	HF
output 2			HF
reset	off , set	Resetting of the meter for heat consumption measurement.	HF

Menu/Parameter (Display)	Setting range	Description	Access
expert / Energy generator / reset			
reset	off , set	Resetting of the parameters in the "Energy generator" menu to factory presets, dependent on access rights.	HF

INSTALLER

USER

8.11 MENU – SOLAR

Menu/Parameter (Display)	Description
.../solar/information	
state	Display of the current status
	Off
	On
	Emergency mode
	Blocking time
	Anti-lock system
	Start time
	Manual mode
	Frost protection (with recooling)
	Minimum runtime
Start time	
valve 1	Status display for valve 1 with East-West circuit (option).
current temperature VF1	Display of the current temperature FS1 (solar field 1).
valve 2	Status display for valve 2 with East-West circuit (option).
current temperature VF2	Display of the current temperature FS2 (solar field 2).
current temperature RF	Display of the current temperature of the return flow sensor (option).
current temperature PF	Display of the current temperature of the buffer storage.
pump	Display of the current status of the solar circuit Pump.
valve	Status display of the solar charging valve (SLV).
current temperature SLVF	Display of the current temperature of the solar charging valve sensor (SLVS).
starts	Display of the number of Pump starts of the solar charging Pump.
runtime	Display of the solar charging Pump runtime.
thermal output	Display of the current Thermal output Solar in KW.
heat quantity	Current heat quantity meter reading for solar in KWh.

Menu/Parameter (Display)	Setting range	Description	Access
.../solar/basic settings			
Switch on difference	1.0 ... 10.0 K ... 30.0	Activate the differential setting for the solar circuit pump. Start charging: If actual temperature < Setpoint - activates difference	HF
Switch-off difference	2.0 ... 5.0 K ... 27.0	Deactivate the differential setting for the solar circuit pump.	HF
minimum temperature	off, 10,0 ... 20,0 °C ... 110,0	Minimum temperature setting for differential control release.	HF
maximum temperature	off, 20,0 ... 110,0 °C ... 210,0	Maximum temperature setting for forced switching on of the solar circuit Pump.	HF
Limit stop	off, 20,0 ... 110,0 °C ... 250,0	Setting of the maximum collector flow for final switch- off.	HF
storage maximum temperature	off, 20,0 ... 7.0 °C ... 110.0	Maximum temperature setting for the solar storage.	HF
operation mode	parallel , priority energy generator, priority hot water, priority buffer	Selection of the operation mode for solar control.	HF
timelock	off , 0,5 ... 24h	Time setting for the cycling interruption of the energy generator. The cycling interruption serves to prevent frequent switching between solar charging and energy generator charging.	HF
parallel	off , 1,0 ... 30 K	Temperature setting for the solar parallel switchover. The switchover takes place if the set temperature differential relative to the Setpoint is undershot.	HF
changeover time	off, 1,0 ... 30.0 Min ... 60,0 Min	Checking interval setting for the solar charging switchover.	HF
changeover temperature	off, 20,0 ... 7.0 °C ... 110.0	Temperature setting for the solar charging switchover.	HF
frost protection	off , -15.0 10.0 °C	Frost protection limit setting of the heat transfer medium of the solar thermal system. If the outside temperature falls below the frost protection limit set here, back heating of the collector is performed from the buffer storage.	HF
recooling	off , 5.0 50.0 K	Temperature differential setting for the recooling function. If the set temperature difference is undershot, the solar circuit Pump is switched off.	HF
Forced draining	off , hot water, heating circuit, Heating buffer, external	Selection of the type of forced draining for the solar storage.	HF
name	Alphanumeric, maximum of 15 characters, no special characters	Entry of the name for the solar control unit.	HF

Menu/Parameter (Display)	Setting range	Description	Access
... / solar / pump			
minimum runtime	off , 0,5 ... 360 Min	Minimum runtime setting of the solar circuit Pump.	HF
break time	off , 0,5 ... 99 Min	Break duration setting of the solar circuit Pump.	HF
anti-lock system	off , 5 ... 20 ... 300 sec	Runtime setting for the anti-lock protection of the solar circuit Pump.	HF
switch on mode	constant mode , temperature diffusion, setpoint	Selection of the operation mode for the solar circuit Pump.	HF
Voltage break	off , 0,1 ... 10 V	Interruption voltage setting of the solar circuit Pump.	HF
start time	off , 1 ... 10 ... 240 sec	Start time setting of the solar circuit Pump.	HF
start output	0 ... 100 %	Start capacity setting of the solar circuit Pump.	HF
output	1 ... 100 %	Capacity setting of the solar circuit Pump.	HF
minimum voltage	0,0 ... 5,0 ... 10 V	Minimum voltage setting of the solar circuit Pump.	HF
minimum output	0 ... 50 ... 100 %	Minimum capacity setting of the solar circuit Pump.	HF
maximum voltage	0,0 ... 10 V	Maximum voltage setting of the solar circuit Pump.	HF
maximum output	0 ... 100 %	Minimum capacity setting of the solar circuit Pump.	HF
regulation gain	1,0 ... 2,0 ... 50 %/K	Gain setting of the PI controller for the solar circuit Pump.	HF
regulation adjust time	1 ... 270 ... 600 sec	Reset time setting of the PI controller for the solar circuit Pump.	HF
regulation scan time	1 ... 20 ... 600 sec	Sample time setting of the PI controller for the solar circuit Pump.	HF
temperature spread	2,0 ... 10.0 30.0 K	Temperature spread setting for the "Temperature spread" switch-on type.	HF
manual driving	off , 0,5 10.0 Min	Manual mode of the solar circuit Pump for filling or bleeding.	HF
reset counter @number	off , set	Resetting of the meter (Pump starts, Pump runtime).	BE/HF

Menu/Parameter (Display)	Setting range	Description	Access
... / solar / heat balance			
volume flow	off , 0,5 ... 300 L/min or L/pulse	Setting of the volume flow for heat consumption measurement or setting of the units for pulse input of a flow meter.	HF
medium density	0,8 ... 1,05 ... 1,2 kg/L	Density setting of the heat transfer medium for heat consumption measurement.	HF
medium heat capacity	1,0 ... 3,6 ... 50 kJ/kg*K	Heat capacity setting of the heat transfer medium for heat consumption measurement.	HF
reset	off , set	Resetting of the meter for heat consumption measurement.	HF

Menu/Parameter (Display)	Setting range	Description	Access
... / solar / reset			
reset	off , set	Resetting of the parameters in the "solar" menu to factory presets, dependent on access rights.	BE/HF

8.12 MENU – RETURN FLOW

Menu/Parameter (Display)	Description
expert / Return flow / information	
Setpoint status	Display of the current status
	Display of the return Setpoint.
Current temperature	Display of the current return temperature (only mixed heating circuit).
pump	State of the return pump On/Off
Mixing valve	Calculated position of the actuator

Menu/Parameter (Display)	Setting range	Description	Access
expert / Return flow / basic settings			
Setpoint	off, 10 ... 20°C ... 95°C	Setpoint return flow	HF
switching difference	1, 2K, ... 20K	Switching difference Pump	HF

Menu/Parameter (Display)	Setting range	Description	Access
expert / Return flow / pump			
anti-lock system	off, 5 ... 300 Sec	Setting the runtime for the anti-lock protection of the return Pump.	HF
switch on mode	Constant mode, Temperature diffusion, setpoint	Selection of the operation mode for the speed control of the return Pump.	HF
interrupting voltage	off, 0,1 ... 10 V	Setting the switch-off voltage of the return Pump.	HF
start time	off, 1 ... 10 ... 240 Sec	Setting the start time of the return Pump.	HF
start output	0 ... 100 %	Setting the starting output of the return Pump.	HF
output	1 ... 100 %	Setting the output of the return Pump	HF
minimum voltage	0,0 ... 5,0 ... 10 V	(for constant operation switch-on mode)	HF
minimum output	0 ... 50 ... 100 %	Setting the minimum voltage of the return Pump.	HF
maximum voltage	0,0 ... 10 V	Setting the minimum output of the return Pump.	HF
maximum output	0 ... 100 %	Setting the maximum voltage of the return Pump.	HF
regulation gain	1,0 ... 2,0 ... 50 %/K	Setting the gain of the PID controller for the return Pump.	HF
regulation adjust time	1 ... 270 ... 600 Sec	Setting the adjustment time of the PID controller for the return Pump.	HF
regulation scan time	1 ... 20 ... 600 Sec	Setting the scan time of the PID controller for the return Pump.	HF
temperature spread	2,0 ... 10,0 ... 20,0 K	Setting of the temperature spread for the “Temperature spread” switch-on mode.	HF

Menu/Parameter (Display)	Settingrange	Description	Access
expert/Return flow/ mixing valve			
regulation gain	1,0... 2,0 ... 50%/K	Setting the gain of the PID controller for the mixing valve.	HF
regulation adjust time	1... 270 ... 600Sec	Setting the adjustment time of the PID controller for the mixing valve.	HF
regulation scan time	1... 20 ... 600Sec	Setting the scan time of the PID controller for the mixing valve.	HF
runtime	1... 120 ... 600Sec	Running time of the valve actuator.	HF
stop position deactivation	off , on	Valve end position control	HF
anti-locksystem	off, 1... 20 ... 300Sec	Setting the running time for the anti-lock protection of the mixing valve.	HF

Menu/Parameter (Display)	Settingrange	Description	Access
expert/Return flow/ reset			
reset	off , set	Reset the parameters in the menu "Return flow" to factory settings according to the access authorization.	HF

8.13 MENU - EXTRAS

Menu/Parameter (Display)	Description
.../extras/information	
state	Display of the current status
	INFO-1
	INFO-2
	INFO-3
	State fault message input 1
	State fault message input 2
	State fault message input 3
	State fault message output
Summer	

Menu/Parameter (Display)	Setting range	Description	Access
.../extras/fault message input 1/2/3			
delay	off, 0,5 ... 360 min.	Fault message is displayed delayed by the value entered here and, if necessary, stored in the fault stack.	HF
error stack	off, on	Storage of the fault message in the error stack	HF
name	Alphanumeric, maximum of 15 characters, no special characters	Enter the name of the fault signal input.	BE/HF

Menu/Parameter (Display)	Setting range	Description	Access
.../extras/fault message output			
delay	off, 0,5 ... 360 min.	Fault message is displayed delayed by the value entered here and, if necessary, stored in the fault stack.	HF
mode	1, 2, 3	Switching condition due to error significance 1 = Locking 2 = Locking, Blocking, System failures 3 = Locking, Blocking, Warnings, System failures	HF

Menu/Parameter (Display)	Setting range	Description	Access
.../extras/information 1, 2, 3			
name	Alphanumeric, maximum of 15 characters, no special characters	Enter the name of the fault signal input.	BE/HF

8.14 MENU – DIFFERENCE

Menu/Parameter (Display)	Description
... / difference / information	
state	Display of the current status
	Off
	On
	Emergency mode
	Blocking time
	Anti-lock system
	Start time
	Manual mode
	Minimum runtime
Overrun time	
Flow probe actual temperature	Display of the current temperature VF1 (flow temperature heat supplier).
Return probe actual temperature	Display of the current temperature of the return flow sensor (option).
Puf. probe actual temperature	Display of the current temperature of the buffer tank (bottom).
pump	Display of the current state of the pump.
starts	Display of the Pump starts.
runtime	Display of the running time of the pump.
Forced draining	Forced draining active.
thermal output	Display of the current thermal output (KW)
heat quantity	Current reading of the heat quantity meter (KWh).

Menu/Parameter (Display)	Setting range	Description	Access
.../ difference/ basic settings			
Switch on difference	1.0 ... 10.0 K ... 30.0	Setting of the switch on difference for the switching output. Start charging: When actual temperature < Setpoint - power on difference	HF
Switch-off difference	2.0 ... 5.0 K ... 27.0	Setting of the power-off difference of the switching output.	HF
minimum temperature	off, 10,0 ... 20,0°C ... 110,0	Setting of the minimum temperature for enabling differential control	HF
maximum temperature	off, 20,0 ... 110,0°C ... 210,0	Setting of the maximum temperature for forced activation of the switching output.	HF
storage maximum temperature	20,0 ... 75,0°C ... 110,0	Setting of the maximum temperature for the buffer storage tank.	HF
operation mode	parallel , priority energy generator, priority hot water, priority buffer	Selection of the operation mode for the switching output.	HF
time lock	off , 0,5 ... 24h	Setting the time for the cycle block of the energy generator. The cycle block is used to avoid frequent cycling between differential control and charging by the energy generator. (not for parallel operating mode)	HF
parallel	off , 1,0 ... 30 K	Setting temperature for the parallel switchover. If the temperature falls below the set difference to the Setpoint, the switchover takes place.	HF
Forced draining	off , hot water, heating circuit, Heating buffer, external	Selection of the type of forced drainage for the storage tank.	HF
name	Alphanumeric, maximum of 15 characters, no special characters	Enter the name for the switching output.	HF

Menu/Parameter (Display)	Setting range	Description	Access
... / difference / pump			
Overrun time	off, 0,5 ... 360 Min	Setting of the pump run-after time.	HF
anti-lock system	off, 5 ... 20 ... 300 Sec	Setting of the running time for the anti-lock system of the pump.	HF
switch on mode	constant mode , temperature spread, setpoint	Selecting the operation mode for the pump	HF
interrupting voltage	off, 0,1 ... 10 V	Setting the interruption voltage of the pump	HF
start time	off, 1 ... 10 ... 240 Sec	Setting the start time of the pump.	HF
start output	0 ... 100 %	Setting the starting power of the pump.	HF
output	1 ... 100 %	Setting the output of the pump.	HF
minimum voltage	0,0 ... 5,0 ... 10 V	Setting the minimum voltage of the pump.	HF
minimum output	0 ... 50 ... 100 %	Setting the minimum output of the pump.	HF
maximum voltage	0,0 ... 10 V	Setting the maximum voltage of the pump.	HF
maximum output	0 ... 100 %	Setting of the maximum output of the pump.	HF
regulation gain	1,0 ... 2,0 ... 50 %/K	Gain setting of the PI controller for the charging Pump.	HF
regulation adjust time	1 ... 270 ... 600 Sec	Reset time setting of the PI controller for the charging Pump.	HF
regulation scan time	1 ... 20 ... 600 Sec	Setting the scan time of the PI controller for the pump.	HF
temperature spread	2,0 ... 10,0 ... 30,0 K	Temperature spread setting for the "Temperature spread" switch-on type.	HF
manual driving	off, 0,5 ... 10,0 Min	Manual mode of the solid charge Pump	HF
reset counter @number	off, setpoint	Reset the counters (Pump starts, Pump running time).	HF

Menu/Parameter (Display)	Setting range	Description	Access
... / difference / heat balance			
volume flow	off, 0,5 ... 300 L/Min o L/ puls	Setting of the volume flow for heat consumption measurement or setting of the units for pulse input of a flow meter.	HF
medium density	0,8 ... 1,05 ... 1,2 kg/L	Density setting of the heat transfer medium for heat consumption measurement.	HF
medium heat capacity	1,0 ... 3,6 ... 50 kJ/kg*K	Heat capacity setting of the heat transfer medium for heat consumption measurement.	HF
reset	off, set	Resetting of the meter for heat consumption measurement.	HF

Menu/Parameter (Display)	Setting range	Description	Access
... / difference / reset			
reset	off, set	Resetting the parameters in the "difference" menu to factory settings according to the access authorization.	HF

8.15 FAULT MESSAGE

Refer to chapter 9 “Troubleshooting”.

8.16 MENU - CONFIG

Information on system configuration and the values applied to the inputs can be checked in the “config” menu. Additionally, you can make further adjustments to the system, which cannot be made via the setup wizard.

8.16.1 menu - information

The implemented system configuration and the values applied to the inputs can be checked in the “information” submenu.

Menu/Parameter (Display)	Description
... expert / config / information	
measurements	Display of the input states of inputs I1 ... I17 in the heatcon! system. If a function is assigned to an input, the brief description of the function is displayed instead of the input number.
Pin assignment	Display of the input and output assignments in the heatcon! system. If a function is assigned to an input/output, the brief description of the function is displayed as well as the input/output number.
Room mapping	Display of the assignment of the rooms to the heating circuits in the heatcon! system. If a name is assigned to a heating circuit/room, the name is also displayed.
System	Display of software version, commissioning date, "EC" code.

8.16.2 menu - function

Adjustments can be made to the controller functions and the input and output assignments in the “function” submenu as a supplement the setup wizard.

Menu/Parameter (Display)	Setting range	Description	I/O type/Fixed I/O assignment
... expert / config / function / Energy generator 1 o 2			
function		Selection of the type of energy generator. The assignment of the inputs and outputs is dependent on the selected energy generator type.	
	off	No energy generator available.	–
	single-stage burner	Single stage energy generator, actuation On/Off.	A1:BR1; E5:WF
	two-stage burner	Two-stage energy generator, actuation On/Off	A1:BR1; A2:BR2AUF; E5:WF
	power signal on/off	Modulating energy generator, switch on via relay BR1, modulation via digital On/Off signal	A1:BR1; A2:BR2AUF; A3:BR2ZU; E5:WF
	burner control system (OT/Bus) (*)	Energy generator actuation via data bus protocol	GEN-BUS
	temperature signal 10V	Switch on via relay, temperature Setpoint via analogue 0 ... 10V signal	A1:BR1; A14:0-10V; E5:WF
	release contact	Release of an external energy generator via switch contact	A1:BR1
power signal 10V	Modulating energy generator, switch on via relay BR1, modulation via analogue 0 ... 10V signal	A1:BR1; A14:0-10V; E5:WF	

Menu/Parameter (Display)	Setting range	Description	I/O type/Fixed I/O assignment
... expert / config / function / Energy generator 1 o 2			
pump relais	off, Outlet open	Actuation of the energy generator Pump (e.g. KKP, CP)	ARS, ARSP
pump 10V	off, Outlet open	Energy generator Pump speed control - speed actuation signal.	A10V
flow sensor	off, E4:EFI ... E15:EFI	Energy generator Pump speed control - flow temperature (only if Pump 10V is active).	EFI (KTY2K/PT1000)
return flow sensor	off, E4:EFI ... E15:EFI	Energy generator Pump speed control - return flow sensor (only if Pump 10V is active).	EFI (KTY2K/PT1000)
boiler sensor 2	off, E4:EFI ... E15:EFI	Activation of the boiler sensor 2nd	EFI (KTY2K/PT1000)
boiler return flow sensor	off, E4:EFI ... E15:EFI	Energy generator modulation 0-10V, operation mode temperature spreading	EFI (KTY2K/PT1000)
Exhaust gas sensor	off, E4:EFI ... E15:EFI	Flue gas temperature measurement via PT1000 sensor (factory setting I9:ISP)	EFI (PT1000)
BRC1	off, Inlet open	Determination of the energy generator runtime via feedback signal - stage 1	EI (Digital 0/1), EO
BRC2	off, Inlet open	Determination of the energy generator runtime via feedback signal - stage 2	EI (Digital 0/1), EO
diverter valve hot water (UWW)	off, Outlet open	Actuation of the hot water diverter valve.	ARS, ARSP
diverter valve cooling	off, Outlet open	Control of a diverter valve cooling active	ARS, ARSP
Parallel heat generator release	off, Outlet open	Control of an output parallel to the GEN	ARS, ARSP
primary pump	off, Outlet open	The primary Pump is activated when the heating circuit is Requested	ARS, ARSP
Forced draining	off, Outlet open	Control of e.g. a Pump for forced discharge	ARS, ARSP
blocking contact	EI:E1 ... E3, EO:E16,17	Input for an external block of the energy generator	EI (Digital 0/1), EO
heat quantity (HTM)	Configuration of the heat meter function.		
	off	No heat meter activated	
	Volume flow constant	Heat quantity via runtime and medium definition.	
	Flow rate measurement	Heat quantity via flow/return temperature and flow sensor (e.g. vortex). NOTE: Hardware configuration required	
	pulse measurement	Heat quantity via flow/return temperature and pulse input. NOTE: Hardware configuration required	
runtime	Heat quantity via runtime and fixed coefficient of performance (e.g. multi-stage GEN)		
flow sensor	off, E4:EFI ... E15:EFI	Flow sensor assignment for heat meter.	
return flow sensor	off, E4:EFI ... E15:EFI	Return flow sensor assignment for heat meter.	
Volume flow sensor	off, E4:EFI ... E15:EFI	Flowmeter assignment for heat meter. NOTE: Hardware configuration required	
Pulse input	off, E1:EI ... E3:EI, E4:EFI ... E15:EFI	Pulse input assignment for heat meter. NOTE: Hardware configuration required.	

(*) Use this setting (Energy generator 1 = Burner control system) for Immergas appliances (Energy generator 2 = off).

Menu/Parameter (Display)	Setting range	Description	I/O type/Fixed I/O assignment
... expert / config / function / return flow sensor			
return flow sensor	off, E4:EFI ... E15:EFI	Return flow sensor input assignment.	EFI (KTY2K/PT1000)
pump	off, free output	Control of the return Pump	ARS, ARSP
pump 10V	off, free output	Speed control return Pump - control signal speed.	A10V
flowsensor	off, E4:EFI ... E15:EFI	Speed control of feed Pump - flow temperature (only if Pump 10V active).	EFI (KTY2K/PT1000)
return flow sensor	off, E4:EFI ... E15:EFI	Speed control of feed Pump - return flow sensor (only if Pump 10V active).	EFI (KTY2K/PT1000)
Mixing valve	off, Free mixing valve	Mixing circuit as return bypass valve	ARS

Menu/Parameter (Display)	Setting range	Description	I/O type/Fixed I/O assignment
... expert / config / function / total flow			
flow sensor	off, E4:EFI ... E15:EFI	Input assignment for common flow sensor.	EFI (KTY2K/PT1000)

Menu/Parameter (Display)	Setting range	Description	I/O type/Fixed I/O assignment
... expert / config / function / Feed pump			
pump relais	off, Outlet open	Actuation of the feed Pump	ARS, ARSP
pump 10V	off, Outlet open	Feed pump speed control - speed actuation signal.	A10V
flow sensor	off, E4:EFI ... E15:EFI	Feed pump speed control - flow temperature (only if Pump 10V is active).	EFI (KTY2K/PT1000)
return flow sensor	off, E4:EFI ... E15:EFI	Feed pump speed control - return flow sensor (only if Pump 10V is active).	EFI (KTY2K/PT1000)
heat quantity	Configuration of the heat meter function.		
	off	No heat meter activated	
	Volume flow constant	Heat quantity via runtime and medium definition.	
	Flow rate measurement	Heat quantity via flow/return temperature and flow sensor (e.g. vortex). NOTE: Hardware configuration required	
	pulse measurement	Heat quantity via flow/return temperature and pulse input. NOTE: Hardware configuration required	
flow sensor (HTM)	off, E4:EFI ... E15:EFI	Flow sensor assignment for heat meter.	EFI (KTY2K/PT1000)
return flow sensor (HTM)	off, E4:EFI ... E15:EFI	Return flow sensor assignment for heat meter.	EFI (KTY2K/PT1000)
Volume flow sensor (HTM)	off, E4:EFI ... E15:EFI	Flowmeter assignment for heat meter. NOTE: Hardware configuration required	EFI10V
Pulse input (HTM)	off, E1:EI ... E3:EI, E4:EFI ... E15:EFI	Pulse input assignment for heat meter. NOTE: Hardware configuration required.	EI, EFI

Menu/Parameter (Display)	Setting range	Description	I/O type/Fixed I/O assignment
... expert / config / function / Heating buffer			
function	Selection of the heating buffer function. For function description see section "Heating buffer functions".		
	off	No heating buffer available.	
	charge control	Heating buffer with charging control	
	discharge control 1	Heating buffer with discharge control type 1.	
supply	discharge control 2	Heating buffer with discharge control type 2.	
	Supply selection for the heating buffer.		
	off	No active supply by the energy generator.	
	Energy generator	Active supply by the energy generator (Setpoint transfer)	
Heating buffer sensor 1	off, E4:EFI ... E15:EFI	Assignment heating buffer sensor 1 (top)	EFI (KTY2K/PT1000)
Heating buffer sensor 2	off, E4:EFI ... E15:EFI	Assignment heating buffer sensor 2 (bottom)	EFI (KTY2K/PT1000)
pump relais	off, Outlet open	Actuation of the buffer charging/buffer discharging Pump.	ARS, ARSP
pump 10V	off, Outlet open	Speed control of the buffer charging/buffer discharging Pump – speed actuation signal.	A10V
flow sensor	off, E4:EFI ... E15:EFI	Buffer charging/buffer discharging Pump speed control – flow temperature (only if Pump 10V is active).	EFI (KTY2K/PT1000)
return flow sensor	off, E4:EFI ... E15:EFI	Buffer charging/buffer discharging Pump speed control - return flow sensor (only if Pump 10V is active).	EFI (KTY2K/PT1000)
Forced draining	off, Outlet open	Drain valve assignment.	ARS, ARSP
Hydraulic buffer discharge (HPE)	off, Outlet open	Output, hydraulic buffer discharge.	ARS, ARSP
Request contact	off, Inlet open	Input, external Request contact for heating buffer.	EI (Digital 0/1), EO
setpoint connection	off, E13:EFI ... E15:EFI	External Setpoint connection via 0-10V	EFI (voltage in Setpoint temperature)

Menu/Parameter (Display)	Setting range	Description	I/O type/Fixed I/O assignment
... expert / config / function / hot water 1 - 2			
function	Selection of the heating buffer function.		
	off	No hot water storage available.	
	storage pump	DHW charging via storage charging Pump TCP.	
	circulation pump	Actuation of the circulation pump.	
	burner control system	DHW charging via control system.	
supply	Central heating use	DHW charging via electrical Heating usage.	
	Supply selection for the DHW storage.		
	off	No active supply by the energy generator.	
	Energy generator	Active supply by the energy generator (Setpoint transfer)	
	Central heating buffer	Active supply by the energy generator (Setpoint transfer)	

Menu/Parameter (Display)	Setting range	Description	I/O type/Fixed I/O assignment
... expert / config / function / hot water 1 - 2			
storage sensor 1	off, E4:EFI ... E15:EFI	Assignment DHW storage sensor 1 (top)	EFI (KTY2K/PT1000)
storage sensor 2	off, E4:EFI ... E15:EFI	Assignment DHW storage sensor 2 (bottom)	EFI (KTY2K/PT1000)
pump 10V	off, Outlet open	Speed control of the DHW storage charging Pump TCP – speed actuation signal.	A10V
flow sensor	off, E4:EFI ... E15:EFI	Speed control of the DHW storage charging Pump – flow temperature (only if Pump 10V is active).	EFI (KTY2K/PT1000)
return flow sensor	off, E4:EFI ... E15:EFI	Speed control of the DHW storage charging Pump – return flow sensor (only if Pump 10V is active).	EFI (KTY2K/PT1000)
Central heating use	off, Outlet open	Output assignment for a Heating usage.	ARS, ARSP
flow sensor	off, E4:EFI ... E15:EFI	Temperature sensor assignment for storage charging via Heating usage.	EFI (KTY2K/PT1000)
circulation pump	off, Outlet open	Output assignment for DHW circulation pump.	ARS, ARSP
current temperature 1	off, E4:EFI ... E15:EFI	Differential sensor 1 for DHW circulation pump circuit (option)	EFI (KTY2K/PT1000)
current temperature 2	off, E4:EFI ... E15:EFI	Differential sensor 2 for DHW circulation pump circuit (option)	EFI (KTY2K/PT1000)
setpoint connection	off, E13:EFI ... E15:EFI	External Setpoint connection via 0-10V	EFI (voltage in Setpoint)
heat quantity	Configuration of the heat meter function.		
	off	No heat meter activated	
	Volume flow constant	Heat quantity via runtime and medium definition.	
	Flow rate measurement	Heat quantity via flow/return temperature and flow sensor (e.g. vortex). NOTE: Hardware configuration required	
	pulse measurement	Heat quantity via flow/return temperature and pulse input. NOTE: Hardware configuration required	

INSTALLER

USER

Menu/Parameter (Display)	Setting range	Description	I/O type/Fixed I/O assignment
... expert / config / function / heating circuit 1 ... n			
function	Selection of the heating circuit type.		
	off	No heating circuit 1 ... n available.	
	direct circuit	Heating circuit with mixed circuit Pump	
	mixer circuit	Heating circuit with mixer.	
supply heat	Supply selection for the heating buffer.		
	off	No active supply by the energy generator.	
	Energy generator	Active supply by the energy generator (Setpoint transfer)	
	heating buffer	Active supply by the energy generator (Setpoint transfer)	
Cooling power supply	off	No active supply by energy generators.	
	Energy generator	Passive supply by energy generator (transfer of Setpoint, selection only possible if a UKA is activated in the energy generator)	
	diverter valve cooling	Switchover of the cooling diverter valve when cooling is required.	
pump 10V	off, Outlet open	Heating circuit Pump speed control - speed actuation signal.	A10V
flow sensor	off, E4:EFI ... E15:EFI	Heating circuit Pump speed control - flow temperature (only if Pump 10V is active).	EFI (KTY2K/PT1000)
return flow sensor	off, E4:EFI ... E15:EFI	Heating circuit Pump speed control - return flow sensor (only if Pump 10V is active).	EFI (KTY2K/PT1000)
Return flow limitation	off, E4:EFI ... E15:EFI	Sensor input assignment for indirect return temperature limiting of the heating circuit.	EFI (KTY2K/PT1000)
heat quantity (HTM)	Configuration of the heat meter function.		
	off	No heat meter activated	
	Volume flow constant	Heat quantity via runtime and medium definition.	
	Flow rate measurement	Heat quantity via flow/return temperature and flow sensor (e.g. vortex). NOTE: Hardware configuration required	
	pulse measurement	Heat quantity via flow/return temperature and pulse input. NOTE: Hardware configuration required	
flow sensor (HTM)	off, E4:EFI ... E15:EFI	Flow sensor assignment for heat meter.	EFI (KTY2K/PT1000)
return flow sensor (HTM)	off, E4:EFI ... E15:EFI	Return flow sensor assignment for heat meter.	EFI (KTY2K/PT1000)
Volume flow sensor (HTM)	off, E4:EFI ... E15:EFI	Flowmeter assignment for heat meter. NOTE: Hardware configuration required	EFI10V
Pulse input (HTM)	off, E1:EI ... E3:EI, E4:EFI ... E15:EFI	Pulse input assignment for heat meter. NOTE: Hardware configuration required.	EI, EFI

Menu/Parameter (Display)	Setting range	Description	I/O type/Fixed I/O assignment
... expert / config / function / room group 1 ... n			
supply	off	No active supply of the room group	
	heating circuit	Active supply by heating circuit 1 ... n (Setpoint transfer)	
	Central heating buffer	Active supply by the energy generator (Setpoint transfer)	
	Energy generator	Active supply by the energy generator (Setpoint transfer)	

Menu/Parameter (Display)	Setting range	Description	I/O type/Fixed I/O assignment
... expert / config / function / difference 1 ... 3			
function	Selection of the type of differential temperature control. For function description see section "Differential control (solar, solid fuel, and general differential control)".		
	off	No differential temperature control is active.	
	solar	Differential temperature control for integration of a solar thermal system.	
	solid	Differential temperature control for integration of a solid fuel boiler.	
	difference	Simple differential control	
flow sensor	off, E4:EFI ... E15:EFI	Differential controller 1 - hotter temperature NOTE: For PT1000, hardware configuration may be required.	EFI (KTY2K/PT1000)
valve 1	off, Outlet open	Assignment of the first valve with East- West circuit of a solar thermal system.	ARS, ARSP
flow sensor 2	off, E4:EFI ... E15:EFI	Collector sensor of a second solar field with an East-West circuit (only if valve 1 is configured). NOTE: For PT1000, hardware configuration may be required.	EFI (KTY2K/PT1000)
valve 2	off, Outlet open	Assignment of the second valve with an East-West circuit of a solar thermal system (only if flow sensor 2 is assigned).	ARS, ARSP
return flow sensor	off, E4:EFI ... E15:EFI	Assignment of an alternative sensor for the switching difference monitoring of the Pump.	EFI (KTY2K/PT1000)
storage sensor	off, E4:EFI ... E15:EFI	Differential controller 2 - colder temperature. NOTE: For PT1000, hardware configuration may be required	EFI (KTY2K/PT1000)
pump relais	off, Outlet open	Actuation of the differential temperature Pump.	ARS, ARSP
pump 10V	off, Outlet open	Speed control of the differential temperature Pump – speed actuation signal.	A10V
flow sensor	off, E4:EFI ... E15:EFI	Speed control of the differential temperature Pump – flow temperature (only if Pump 10V is active).	EFI (KTY2K/PT1000)
return flow sensor	off, E4:EFI ... E15:EFI	Speed control of the differential temperature Pump – return flow sensor (only if Pump 10V is active).	EFI (KTY2K/PT1000)
diverter valve	off, Outlet open	Assignment of the diverter valve for charging two storages (heating buffer and DHW storage). NOTE: Only with solar differential control.	ARS, ARSP

INSTALLER

USER

Menu/Parameter (Display)	Setting range	Description	I/O type/Fixed I/O assignment
... expert / config / function / difference 1 ... 3			
diverter valve sensor	off, E4:EFI ... E15:EFI	Sensor for switching the diverter valve. NOTE: Only with solar differential control. For PT1000, hardware configuration may be required.	EFI (KTY2K/PT1000)
Forced draining	off, Outlet open	Assignment of an output for forced draining. The output is switched, if the set collector maximum temperature is exceeded.	ARS, ARSP
heat quantity (HTM)	Configuration of the heat meter function.		
	off	No heat meter activated	
	Volume flow constant	Heat quantity via runtime and medium definition.	
	Flow rate measurement	Heat quantity via flow/return temperature and flow sensor (e.g. vortex). NOTE: Hardware configuration required	
	pulse measurement	Heat quantity via flow/return temperature and pulse input. NOTE: Hardware configuration required	
flow sensor (HTM)	off, E4:EFI ... E15:EFI	Flow sensor assignment for heat meter. EFI (KTY2K/PT1000)	
return flow sensor (HTM)	off, E4:EFI ... E15:EFI	Return flow sensor assignment for heat meter.	EFI (KTY2K/PT1000)
Volume flow sensor (HTM)	off, E4:EFI ... E15:EFI	Flowmeter assignment for heat meter. NOTE: Hardware configuration required	EFI10V
Pulse input (HTM)	off, E1:EI ... E3:EI, E4:EFI ... E15:EFI	Pulse input assignment for heat meter. NOTE: Hardware configuration required.	EI, EFI

Menu/Parameter (Display)	Setting range	Description	I/O type/Fixed I/O assignment
... expert / config / function / thermostat			
heating output	off, Outlet open	Output assignment for the thermostat function.	ARS, ARSP
Probe	off, E4:EFI ... E15:EFI	Sensor for the thermostat function. NOTE: For PT1000, hardware configuration may be required.	EFI (KTY2K/PT1000)

Menu/Parameter (Display)	Setting range	Description	I/O type/Fixed I/O assignment
... expert / config / function / diverter valve cooling			
diverter valve cooling	off, Outlet open	Control of a changeover valve Cooling Passive (UKP)	ARS, ARSP

Menu/Parameter (Display)	Setting range	Description	I/O type/Fixed I/O assignment
... expert / config / function / extras			
Outside sensor 2	off, E4:EFI ... E15:EFI	Assignment of a second outside sensor.	EFI (KTY2K/PT1000)
information 1	off, E1:EI ... E17:EO	Only an information value, no function.	
information 2			
information 3			
Fault message input 1	off, E1:EI ... E3:EI, E4:EFI ... E15:EFI E16:EO, E17:EO	Input for reporting an external fault.	EI (Digital 0/1), EO EFI (Digital on/off)
Fault message input 2	off, E1:EI ... E3:EI, E4:EFI ... E15:EFI E16:EO, E17:EO	Input for reporting an external fault.	EI (Digital 0/1), EO EFI (Digital on/off)
Fault message input 3	off, E1:EI ... E3:EI, E4:EFI ... E15:EFI E16:EO, E17:EO	Input for reporting an external fault.	EI (Digital 0/1), EO EFI (Digital on/off)
Fault messages output	off, Outlet open	Output for activation of a signal encoder.	
summer operation mode	off, Outlet open	The output becomes active if all rooms/room groups are in summer shutdown.	
release contact	off, E1:EI ... E17:EO	Input for using a external request contact or modem contact to a room group, heating zone and hot water.	EI (Digital 0/1), EO

INSTALLER

USER

8.16.3 menu - hardware

Hardware settings can be made in the “function” submenu:

- Calibration of the temperature sensor inputs;
- Selection of the input and output types;
- Resetting of the menu to factory settings.

Menu/Parameter (Display)	Setting range	Description
... Expert / config / hardware / calibration		
E4:EFI ... E15:EFI	-5,0 ... 0,0 ... +5,0 K	Offset calibration of the temperature sensor inputs.

Menu/Parameter (Display)	Setting range	Description
... Expert / config / hardware / input		
E1:EI ... E3:EI	digital: indicator off/on	Digital input OFF/ON.
	digital: indicator open/closed	Digital input OPEN/CLOSED (e.g. valve feedback).
	digital: impulse	Pulse input (e.g. pulses from a flowmeter).
E4:EFI ... E12:EFI	KTY2K	Sensor input for KTY temperature sensor.
	PT1000	Sensor input for PT1000 temperature sensor.
	digital: indicator off/on	Digital input OFF/ON.
	digital: indicator open/closed	Digital input OPEN/CLOSED (e.g. valve feedback).
	digital: impulse	Pulse input (e.g. pulses from a flowmeter).
	E13:EFI10V ... E15:EFI10V	KTY2K
PT1000		Sensor input for PT1000 temperature sensor.
digital: indicator off/on		Digital input OFF/ON.
digital: indicator open/closed		Digital input OPEN/CLOSED (e.g. valve feedback).
digital: impulse		Pulse input (e.g. pulses from a flowmeter).
I10V Setpoint temp. [°C]		Analogue input 0 ... 10 V for temperature in °C (Setpoint).

Menu/Parameter (Display)	Setting range	Description
... Expert / config / hardware / output		
test	off, A1:ARSP...A15:10V	Test function for switching outputs. The selected output is activated. Deactivation takes place by selecting “off” or automatic after 5 minutes.
A14-10V, A15-10V	Voltage 0-10V	Analogue output 0 ... 10 VDC
	PWM signal	PWM output

Menu/Parameter (Display)	Setting range	Description
... Expert / config / hardware / reset		
reset	off, set	Resets the menu to the factory settings.

8.17 MENU - HYDRAULIC

Refer to chapter 6.2.2.

9 TROUBLESHOOTING

9.1 DISPLAY OF FAULT MESSAGES

Fault messages are displayed in the heatapp! system depending on the interface (heatcon! MMI, heatapp! APP, PC user interface). Example: the outside sensor connected to input E4 has a wire break.

According to the table "heatcon! Error code": 4-1 = EF Regulator 4 is short-circuited.

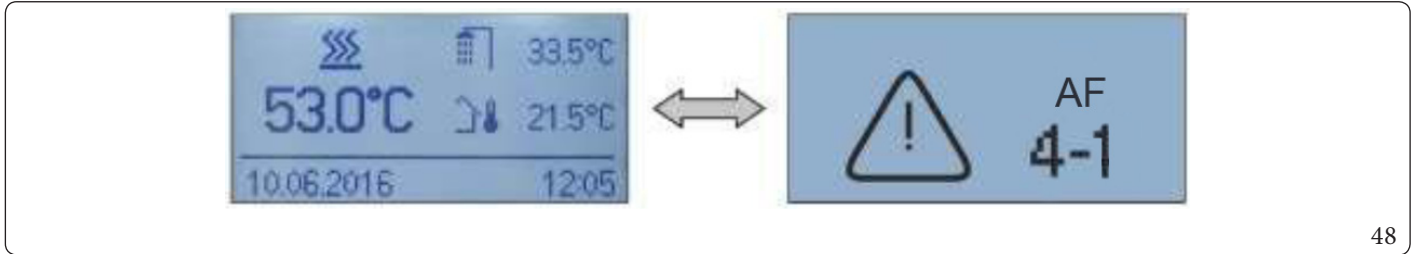

Fault messages are automatically displayed in the heatcon! MMI display in alternation with the basic display. If several fault messages exist simultaneously, they are displayed one after the other.

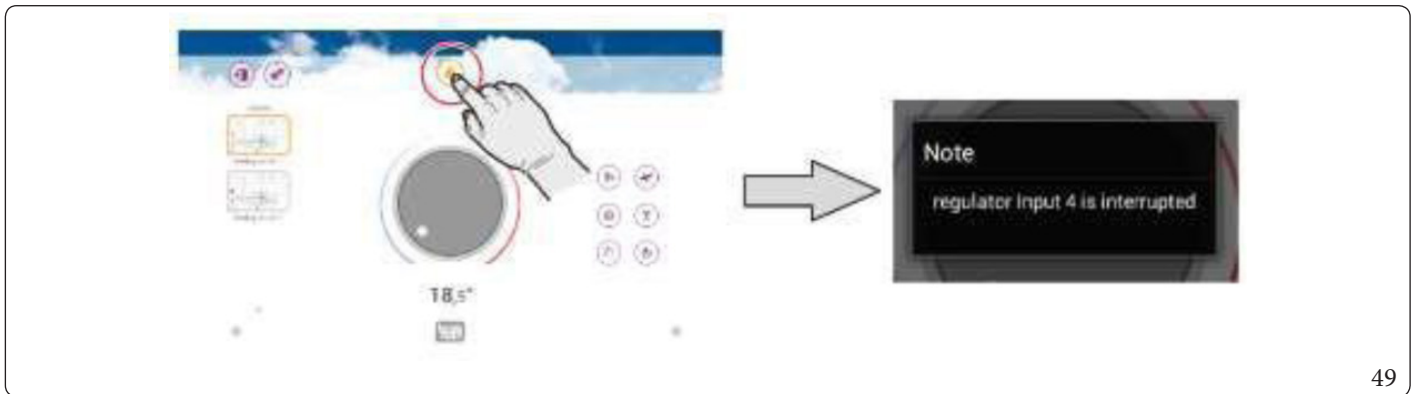

i In the heatapp! App, fault messages are indicated by a triangle symbol.

Tapping the symbol will bring up a message box to be displayed containing the actual fault messages.

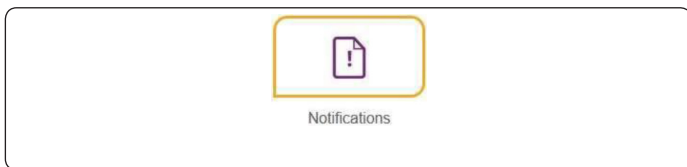

Error messages can also be sent as e-mail messages or push messages. Via the "Notification" button in the PC user interface or in the app in the system menu you can select the send message and the recipient.

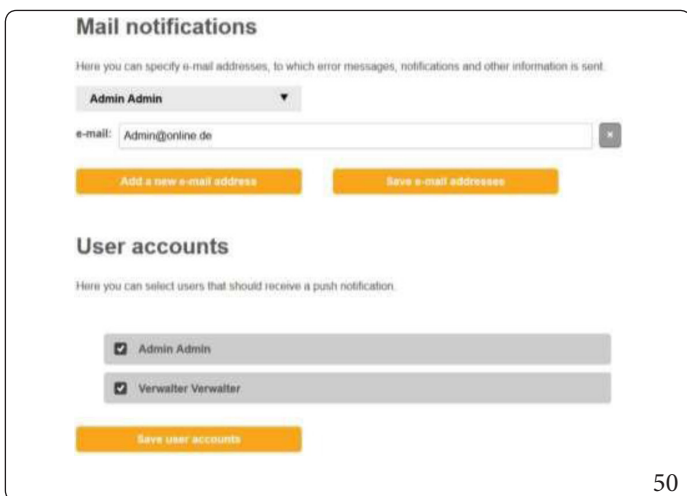

9.2 FAULT MESSAGES OF CONNECTED BURNER CONTROL SYSTEMS

Menu (Display)	Parameter (Display)	Description
expert/System	Error code aut. display	<p>Selection of which fault messages of a machine are displayed and processed in the system (e.g. EO).</p> <ul style="list-style-type: none"> - off: No fault messages of the burner control system are evaluated. - locking: Only locking of the burner control system is evaluated. - Blocking: Only locking and blocking of the burner control system is evaluated. - warning: Locking, blocking and warnings of the burner control system are evaluated.

The heatcon! system offers the possibility of displaying and evaluating fault messages from a burner control system connected via a EEZ-BUS in the heatcon! system.

The fault messages can be filtered in three groups or completely deactivated.

9.3 HEATCON! ERROR CODE

Error code	Error number	Error-state	Disableable	Error location		Error type
W(n)-	GENspecific	System	Yes	Boiler warning	GEN Address 0...n	Boiler warning message.
B(n)-	GENspecific	System	Yes	Boiler, automatic reset block	GEN Address 0...n	Blocking message boiler.
E(n)-	GENspecific	System	Yes	Boiler, manual reset block	GEN Address 0...n	Locking message boiler.
4...15	0	System	No	Sensor	Input E4...E15	Interruption
	1					Short circuit
1...17	7	System	Yes	Fault message	Fault message input	System message
21...24	0	System	No	Sensor	EM-1 Input E1...E4	Interruption
	1					Short circuit
31...34	0	System	No	Sensor	EM-2 Input E1...E4	Interruption
	1					Short circuit
33	5	System	Yes	Energy generator	Emission control	Emission blocking
	6	System	Yes			Emission blocking
49	4	Logical	Yes	Energy generator 2		Setpoint temperature not reached
50	3	System	Yes	Energy generator		Start detection: GEN does not switch on
50	4	Logical	Yes	Energy generator 1		Setpoint temperature not reached
51	4	Logical	Yes	Domestic hot water		Setpoint temperature not reached
53...76	5	Logical	Yes	Room	Room 1...24	Room temperature not reached
	15	System	No			Valve configured without sensor
	21	System	No			Heating supply not available
						Cooling supply not available
70	6	System	No	Bus	Machine	Fault connection to machine
70	1	System	No	EC		Internal fault
70	9					
71	1					
71	6	System	No	Bus	EM-1	Fault connection to EM-1
72	6	System	No	Bus	EM-2	Fault connection to EM-2
81...85	4	Logical	Yes	Heating circuit	Heating circuit 1.5	Setpoint temperature not reached
101...124	1...4	System	Yes	Room	Room 1...24	Wireless valve 1...4 Low battery
	9	System	Yes			Room sensor Low battery
201...224	1...4	System	No	Room	Room 1...24	Wireless valve 1...4 no radio connection
	9					Room sensor no radio connection

INSTALLER

USER

9.4 FAULT MESSAGES

Error code		Display MMI	Display App	Error description
Code	No.			
1	7	Display occurs according to the function assignment	Controller EF 1 reports a malfunction	System message - Fault message input active
4	0	Display occurs according to the function assignment	Controller EF 4 is interrupted	Input E4 (Sensor-) Interruption
4	1	Display occurs according to the function assignment	Controller EF 4 is short circuited	Input E4 (Sensor) Short circuit
5	0	Display occurs according to the function assignment	Controller EF 5 is interrupted	Input E5 (Sensor-) Interruption
5	1	Display occurs according to the function assignment	Controller EF 5 is short circuited	Input E6 (Sensor-) Interruption
6	0	Display occurs according to the function assignment	Controller EF 6 is interrupted	Input E6 (Sensor-) Interruption
6	1	Display occurs according to the function assignment	Controller EF 6 is short circuited	Input E6 (Sensor) Short circuit
7	0	Display occurs according to the function assignment	Controller EF 7 is interrupted	Input E7 (Sensor-) Interruption
7	1	Display occurs according to the function assignment	Controller EF 7 is short circuited	Input E7 (Sensor) Short circuit
8	0	Display occurs according to the function assignment	Controller EF 8 is interrupted	Input E8 (Sensor-) Interruption
8	1	Display occurs according to the function assignment	Controller EF 8 is short circuited	Input E8 (Sensor) Short circuit
9	0	Display occurs according to the function assignment	Controller EF 9 is interrupted	Input E9 (Sensor-) Interruption
9	1	Display occurs according to the function assignment	Controller EF 9 is short circuited	Input E9 (Sensor) Short circuit
10	0	Display occurs according to the function assignment	Controller EF 10 is interrupted	Input E10 (Sensor-) Interruption
10	1	Display occurs according to the function assignment	Controller EF 10 is short circuited	Input E10 (Sensor) Short circuit
11	0	Display occurs according to the function assignment	Controller EF 11 is interrupted	Input E11 (Sensor-) Interruption
11	1	Display occurs according to the function assignment	Controller EF 11 is short circuited	Input E11 (Sensor) Short circuit
12	0	Display occurs according to the function assignment	Controller EF 12 is interrupted	Input E12 (Sensor-) Interruption
12	1	Display occurs according to the function assignment	Controller EF 12 is short circuited	Input E12 (Sensor) Short circuit
13	0	Display occurs according to the function assignment	Controller EF 13 is interrupted	Input E13 (Sensor-) Interruption
13	1	Display occurs according to the function assignment	Controller EF 13 is short circuited	Input E13 (Sensor) Short circuit
14	0	Display occurs according to the function assignment	Controller EF 14 is interrupted	Input E14 (Sensor-) Interruption
14	1	Display occurs according to the function assignment	Controller EF 14 is short circuited	Input E14 (Sensor) Short circuit
15	0	Display occurs according to the function assignment	Controller EF 15 is interrupted	Input E15 (Sensor-) Interruption
15	1	Display occurs according to the function assignment	Controller EF 15 is short circuited	Input E15 (Sensor) Short circuit

Error code		Display MMI	Display App	Error description
Code	No.			
21	0	Display occurs according to the function assignment	Extension module 1 EF 1 is interrupted	EM-1 Input E1 (Sensor) Interruption
21	1	Display occurs according to the function assignment	Extension module 1 EF 1 is short circuited	EM-1 Input E1 (Sensor) Short circuit
22	0	Display occurs according to the function assignment	Extension module 1 EF 2 is short circuited	EM-1 Input E2 (Sensor) Interruption
22	1	Display occurs according to the function assignment	Extension module 1 EF 2 is short circuited	EM-1 Input E2 (Sensor) Short circuit
23	0	Display occurs according to the function assignment	Extension module 1 EF 3 is short circuited	EM-1 Input E3 (Sensor) Interruption
23	1	Display occurs according to the function assignment	Extension module 1 EF 3 is short circuited	EM-1 Input E3 (Sensor) Short circuit
24	0	Display occurs according to the function assignment	Extension module 1 EF 4 is short circuited	EM-1 Input E4 (Sensor) Interruption
24	1	Display occurs according to the function assignment	Extension module 1 EF 4 is short circuited	EM-1 Input E4 (Sensor) Short circuit
31	0	Display occurs according to the function assignment	Extension module 2 EF 1 is short circuited	EM-2 Input E1 (Sensor) Interruption
31	1	Display occurs according to the function assignment	Extension module 2 EF 1 is short circuited	EM-2 Input E1 (Sensor) Short circuit
32	0	Display occurs according to the function assignment	Extension module 2 EF 2 is short circuited	EM-2 Input E2 (Sensor) Interruption
32	1	Display occurs according to the function assignment	Extension module 2 EF 2 is short circuited	EM-2 Input E2 (Sensor) Short circuit
33	0	Display occurs according to the function assignment	Extension module 2 EF 3 is short circuited	EM-2 Input E3 (Sensor) Interruption
33	1	Display occurs according to the function assignment	Extension module 2 EF 3 is short circuited	EM-2 Input E3 (Sensor) Short circuit
33	5	Energy generator	Energy generator Exhaust is blocked	Flue gas monitoring - flue gas block
33	6	Energy generator	Energy generator Exhaust is locked	Flue gas monitoring - flue gas lock
34	0	Display occurs according to the function assignment	Extension module 2 EF 4 is short circuited	EM-2 Input E4 (Sensor) Interruption
34	1	Display occurs according to the function assignment	Extension module 2 EF 4 is short circuited	EM-2 Input E4 (Sensor) Short circuit
40	4	Energy generator	Energy generator 2 Setpoint was not reached	GEN 2 Setpoint temperature not reached within 90 minutes
50	3	Energy generator	Energy generator does not switch on	GEN- Minimum temperature is not reached within the set starter detection
50	4	Energy generator	Energy generator 1 Setpoint was not reached	GEN 1 Setpoint temperature not reached within 90 minutes
51	4	Domestic hot water	Domestic hot water 1 Setpoint was not reached	Domestic hot water Setpoint temperature not reached within 240 minutes

Error code		Display MMI	Display App	Error description
Code	No.			
53	5	Room 1 ...	Room 1/individual room name) Setpoint was not reached	Room-Setpoint temperature not reached within 180 minutes - Room 1
53	20	Room 1 ...	(Room 1/individually created room name) Supply Heating mode is not registered	Room supply is not available (deactivated)
53	21	Room 1 ...	(Room 1/individually created room name) Supply Cooling mode is not registered	Room supply is not available (deactivated)
54	5	Room 2 ...	Room 2/individual room name) Setpoint was not reached	Room-Setpoint temperature not reached within 180 minutes - Room 2
54	20	Room 2 ...	(Room 2/individually created room name) Supply Heating mode is not registered	Room supply is not available (deactivated)
54	21	Room 2 ...	(Room 2/individually created room name) Supply Cooling mode is not registered	Room supply is not available (deactivated)
55	5	Room 3 ...	(Room 3/individual room name) Setpoint was not reached	Room-Setpoint temperature not reached within 180 minutes - Room 3
55	20	Room 3 ...	(Room 3/individually created room name) Supply Heating mode is not registered	Room supply is not available (deactivated)
55	21	Room 3 ...	(Room 3/individually created room name) Supply Cooling mode is not registered	Room supply is not available (deactivated)
56	5	Room 4 ...	(Room 4/individual room name) Setpoint was not reached	Room-Setpoint temperature not reached within 180 minutes - Room 4
56	20	Room 4 ...	(Room 4/individually created Room name) Supply for heating operation is not registered	Room supply is not available (deactivated)
56	21	Room 4 ...	(Room 4/individually created room name) Supply Cooling mode is not registered	Room supply is not available (deactivated)
57	5	Room 5 ...	(Room 5/individual room name) Setpoint was not reached	Room-Setpoint temperature not reached within 180 minutes - Room 5
57	20	Room 5 ...	(Room 5/individually created Room name) Supply for heating operation is not registered	Room supply is not available (deactivated)
57	21	Room 5 Room 7	(Room 5/individually created room name) Supply Cooling mode is not registered	Room supply is not available (deactivated)
58	5	Room 6 ...	(Room 6/individual room name) Setpoint was not reached	Room-Setpoint temperature not reached within 180 minutes - Room 6

Error code		Display MMI	Display App	Error description
Code	No.			
58	20	Room 6 ...	(Room 6/individually created Room name) Supply for heating operation is not registered	Room supply is not available (deactivated)
58	21	Room 6 ...	(Room 6/individually created room name) Supply Cooling mode is not registered	Room supply is not available (deactivated)
59	5	Room 7 ...	(Room 7/individual room name) Setpoint was not reached	Room-Setpoint temperature not reached within 180 minutes - Room 7
59	20	Room 7 ...	(Room 7/individually created Room name) Supply for heating operation is not registered	Room supply is not available (deactivated)
59	21	Room 7 ...	(Room 7/individually created room name) Supply Cooling mode is not registered	Room supply is not available (deactivated)
60	5	Room 8 ...	(Room 8/individual room name) Setpoint was not reached	Room-Setpoint temperature not reached within 180 minutes - Room 8
60	20	Room 8 ...	(Room 3/individually created Room name) Supply for heating operation is not registered	Room supply is not available (deactivated)
60	21	Room 8 ...	(Room 8/individually created room name) Supply Cooling mode is not registered	Room supply is not available (deactivated)
61	5	Room 9 ...	(Room 9/individual room name) Setpoint was not reached	Room-Setpoint temperature not reached within 180 minutes - Room 9
61	20	Room 9 ...	(Room 9/individually created Room name) Supply for heating operation is not registered	Room supply is not available (deactivated)
61	21	Room 9 ...	(Room 9/individually created room name) Supply Cooling mode is not registered	Room supply is not available (deactivated)
62	5	Room 10 ...	(Room 10/individual room name) Setpoint was not reached	Room-Setpoint temperature not reached within 180 minutes - Room 10
62	20	Room 10 ...	(Room 10/individually created Room name) Supply for heating operation is not registered	Room supply is not available (deactivated)
62	21	Room 10 ...	(Room 10/individually created room name) Supply Cooling mode is not registered	Room supply is not available (deactivated)
63	5	Room 11 ...	(Room 11/individual room name) Setpoint was not reached	Room-Setpoint temperature not reached within 180 minutes - Room 11
63	20	Room 11 ...	(Room 11/individually created Room name) Supply for heating operation is not registered	Room supply is not available (deactivated)

Error code		Display MMI	Display App	Error description
Code	No.			
63	21	Room 11 ...	(Room 11/individually created room name) Supply Cooling mode is not registered	Room supply is not available (deactivated)
64	5	Room 12 ...	(Room 12/individual room name) Setpoint was not reached	Room-Setpoint temperature not reached within 180 minutes - Room 12
64	20	Room 12 ...	(Room 12/individually created Room name) Supply for heating operation is not registered	Room supply is not available (deactivated)
64	21	Room 12 ...	(Room 12/individually created room name) Supply Cooling mode is not registered	Room supply is not available (deactivated)
65	5	Room 13 ...	(Room 13/individual room name) Setpoint was not reached	Room-Setpoint temperature not reached within 180 minutes - Room 13
65	20	Room 13 ...	(Room 13/individually created Room name) Supply for heating operation is not registered	Room supply is not available (deactivated)
65	21	Room 13 ...	(Room 13/individually created room name) Supply Cooling mode is not registered	Room supply is not available (deactivated)
66	5	Room 14 ...	(Room 14/individual room name) Setpoint was not reached	Room-Setpoint temperature not reached within 180 minutes - Room 14
66	20	Room 14 ...	(Room 13/individually created Room name) Supply for heating operation is not registered	Room supply is not available (deactivated)
66	21	Room 14 ...	(Room 14/individually created room name) Supply Cooling mode is not registered	Room supply is not available (deactivated)
67	5	Room 15 ...	(Room 15/individual room name) Setpoint was not reached	Room-Setpoint temperature not reached within 180 minutes - Room 15
67	20	Room 15 ...	(Room 15/individually created Room name) Supply for heating operation is not registered	Room supply is not available (deactivated)
67	21	Room 15 ...	(Room 15/individually created room name) Supply Cooling mode is not registered	Room supply is not available (deactivated)
68	5	Room 16 ...	(Room 16/individual room name) Setpoint was not reached	Room-Setpoint temperature not reached within 180 minutes - Room 16
68	20	Room 16 ...	(Room 16/individually created Room name) Supply for heating operation is not registered	Room supply is not available (deactivated)

Error code		Display MMI	Display App	Error description
Code	No.			
68	21	Room 16 ...	(Room 16/individually created room name) Supply Cooling mode is not registered	Room supply is not available (deactivated)
69	5	Room 17 ...	(Room 17/individual room name) Setpoint was not reached	Room-Setpoint temperature not reached within 180 minutes - Room 17
69	20	Room 17 ...	(Room 17/individually created Room name) Supply for heating operation is not registered	Room supply is not available (deactivated)
69	21	Room 17 ...	(Room 17/individually created room name) Supply Cooling mode is not registered	Room supply is not available (deactivated)
70	1	System	System	Internal error
70	5	Room 18 ...	(Room 18/individual room name) Setpoint was not reached	Room-Setpoint temperature not reached within 180 minutes - Room 18
70	6	System	Energy generator 1 no data connection Energy generator 2 no data connection	Fault in the bus connection to the machine
70	1	System	System	Internal error
70	5	Room 18 ...	(Room 18/individual room name) Setpoint was not reached	Room-Setpoint temperature not reached within 180 minutes - Room 18
70	6	System	Energy generator 1 no data connection Energy generator 2 no data connection	Fault in the bus connection to the machine
70	9	System	System	Internal error
70	20	Room 18 ...	(Room 18/individually created Room name) Supply for heating operation is not registered	Room supply is not available (deactivated)
70	21	Room 18 ...	(Room 18/individually created room name) Supply Cooling mode is not registered	Room supply is not available (deactivated)
71	1	System	System	Internal error
71	5	Room 19 ...	(Room 19/individual room name) Setpoint was not reached	Room-Setpoint temperature not reached within 180 minutes - Room 19

INSTALLER

USER

Error code		Display MMI	Display App	Error description
Code	No.			
71	6	System	Extension module 1 no data connection	Extension module 1 no data connection to the EC
71	20	Room 19 ...	(Room 19/individually created Room name) Supply for heating operation is not registered	Room supply is not available (deactivated)
71	21	Room 19 ...	(Room 19/individually created room name) Supply Cooling mode is not registered	Room supply is not available (deactivated)
72	5	Room 20 ...	(Room 20/individual room name) Setpoint was not reached	Room-Setpoint temperature not reached within 180 minutes - Room 20
72	6	System	Extension module 2 no data connection	Extension module 2 no data connection to the EC
72	20	Room 20 ...	(Room 20/individually created Room name) Supply for heating operation is not registered	Room supply is not available (deactivated)
72	21	Room 20 ...	(Room 20/individually created room name) Supply Cooling mode is not registered	Room supply is not available (deactivated)
73	5	Room 21 ...	(Room 21/individual room name) Setpoint was not reached	Room-Setpoint temperature not reached within 180 minutes - Room 21
73	20	Room 21 ...	(Room 21/individually created Room name) Supply for heating operation is not registered	Room supply is not available (deactivated)
73	21	Room 21 ...	(Room 21/individually created room name) Supply Cooling mode is not registered	Room supply is not available (deactivated)
74	5	Room 22 ...	(Room 22/individual room name) Setpoint was not reached	Room-Setpoint temperature not reached within 180 minutes - Room 22
74	20	Room 22 ...	(Room 22/individually created Room name) Supply for heating operation is not registered	Room supply is not available (deactivated)
74	21	Room 22 ...	(Room 22/individually created room name) Supply Cooling mode is not registered	Room supply is not available (deactivated)
75	5	Room 23 ...	(Room 23/individual room name) Setpoint was not reached	Room-Setpoint temperature not reached within 180 minutes - Room 23
75	20	Room 23 ...	(Room 23/individually created Room name) Supply for heating operation is not registered	Room supply is not available (deactivated)

Error code		Display MMI	Display App	Error description
Code	No.			
75	21	Room 23 ...	(Room 23/individually created room name) Supply Cooling mode is not registered	Room supply is not available (deactivated)
76	5	Room 24 ...	(Room 24/individual room name) Setpoint was not reached	Room-Setpoint temperature not reached within 180 minutes - Room 24
76	20	Room 24 ...	(Room 23/individually created Room name) Supply for heating operation is not registered	Room supply is not available (deactivated)
76	21	Room 24 ...	(Room 24/individually created room name) Supply Cooling mode is not registered	Room supply is not available (deactivated)
81	4	Heating circuit 1	Heating circuit 1 Setpoint was not reached	Heating circuit 1 Setpoint temperature not reached within 60 minutes
82	4	Heating circuit 2	Heating circuit 2 Setpoint was not reached	Heating circuit 2 Setpoint temperature not reached within 60 minutes
83	4	Heating circuit 3	Heating circuit 3 Setpoint was not reached	Heating circuit 3 Setpoint temperature not reached within 60 minutes
84	4	Heating circuit 4	Heating circuit 4 Setpoint was not reached	Heating circuit 4 Setpoint temperature not reached within 60 minutes
85	4	Heating circuit 5	Heating circuit 5 Setpoint was not reached	Heating circuit 5 Setpoint temperature not reached within 60 minutes
90	0	(individually created name)	Fault message input	System message – Fault message input active



Error codes from 101 to 224 refer to the heatapp system! not supplied by Immergas.

10 TECHNICAL DATA

Installation	EC 1351 Pro top hat rail installation in the energy generator MMI 200 in standard cut-out 144 x 96 mm
Operating system	Embedded, Linux
Network connections, USB	<ul style="list-style-type: none"> • RJ45 Ethernet • USB 2.0
Power supply	230 V ± 10 %, 50 Hz
Power consumption	max. 9VA
Protection class	I with functional earth
IP rating	IP00
Fuse	User-supplied (MAX 10A)
Energy generator bus	heatcon! EC 1351 Pro RS485 EbV GEN-Bus
Ambient conditions <ul style="list-style-type: none"> • Storage temperature • Operating temperature 	-25 ... +60 °C -10 ... +50 °C
Connections screw terminals	<ul style="list-style-type: none"> • Mains voltage L, N, PE • 3 x potential-free relay ARSP, max. 230V/2A • 10 relay 230V ONOR, max. 2A, sum current: max. 10A • 2 x opto-coupler input IOC 230V • 9 x sensor pulse input EFI • 3 x sensor pulse 0...10V input EFI 10V • 3 x pulse input PI • 2 x output 0...10V PWM O10VP • Energy generator bus RS485 EbV GEN bus • Connection room device bus RC (2-wire bus) • Connection control unit MMI 200 • EbV device bus
Standards	DIN EN 60730
Dimensions EC 1351 Pro MMI 200	210 x 90 x 61 mm (length x width x height) with top-hat rail 144 x 96 x 29 mm (length x width x height)
Weight EC 1351 Pro MMI 200	335 g 125 g
MMI display dimensions	Graphic display 70 x 35 mm
MMI operation	7 speed buttons 1 rotary push button
MMI colour	Black
Colour heatcon! EC 1351 Pro	Grey

Class	Contribution to room central heating seasonal energy efficiency	Description
VI	+4%	Victrix Pro V2 cascade and zone regulator kit coupled to Victrix Pro V2 zone manager kit and external temperature sensor
VIII	+5%	Victrix Pro V2 cascade and zone regulator kit coupled to three or more Victrix Pro V2 zone manager kit

10.1 SWITCHING TIMESTABLE

Room	Day	Switchingtime 1	Switchingtime 2	Switchingtime 3
	mo			
	tu			
	we			
	th			
	fr			
	sa			
	su			
	mo			
	tu			
	we			
	th			
	fr			
	sa			
	su			
	mo			
	tu			
	we			
	th			
	fr			
	sa			
	su			
	mo			
	tu			
	we			
	th			
	fr			
	sa			
	su			
	mo			
	tu			
	we			
	th			
	fr			
	sa			
	su			

INSTALLER

USER

Login data



Write down your login details for your heatcon system! below:

Userlevel	User name	Password



Create a setup log file and a data backup after completing the installation.

10.2 CABLELENGTHS AND CROSS-SECTIONS

Cables for mains voltage (power supply, burner, Pumps, actuators)	
Cross-section	1.5 mm ²
Maximum cable length	Unlimited cable length as part of an in-house installation

Cables for safety extra low voltage (sensors, analogue signal cables, contacts, etc.)	
Cross-section	0.5 mm ²
Maximum cable length	100 m (double line). Longer distances are possible but increase the risk of interference.

Cables for safety extra low voltage (sensors, analogue signal cables, contacts, etc.)	
Cross-section	0.6 mm
Type	J-Y(St)Y 1 x 2 x 0.6 mm
Maximum cable length	50 m (double line), longest section between the heatcon! EC and the devices). Longer distances are possible but increase the risk of interference.

10.3 RESISTANCE VALUES FOR SENSORS OF TYPE KTY20

°C	kΩ	°C	kΩ	°C	kΩ	°C	kΩ
-20	1.386	0	1.63	20	1.922	70	2.786
-18	1.393	2	1.658	25	2	75	2.883
-16	1.418	4	1.686	30	2.08	80	2.982
-14	1.444	6	1.714	35	2.161	85	3.082
-12	1.469	8	1.743	40	2.245	90	3.185
-10	1.495	10	1.772	45	2.33	95	3.29
-8	1.522	12	1.802	50	2.418	100	3.396
-6	1.549	14	1.831	55	2.507		
-4	1.576	16	1.862	60	2.598		
-2	1.603	18	1.892	65	2.691		

10.4 RESISTANCE VALUES FOR SENSORS OF TYPE PT1000

°C	kΩ	°C	kΩ	°C	kΩ	°C	kΩ
0	1000	80	1308.93	140	1535.75	280	2048.76
10	1039.02	85	1327.99	150	1573.15	300	2120.19
20	1077.93	90	1347.02	160	1610.43	320	2191.15
25	1093.46	95	1366.03	170	1647.6	340	2261.66
30	1116.72	100	1385	180	1684.65	360	2331.69
40	1155.39	105	1403.95	190	1721.58	380	2401.27
50	1193.95	110	1422.86	200	1758.4	400	2470.38
60	1232.72	115	1441.75	220	1831.68	450	2641.12
70	1270.72	120	1460.61	240	1904.51	500	2811
75	1289.84	130	1498.24	260	1976.86		



The heatcon! EC 1351 Pro is supplied with a top hat rail housing. Protection class I, earth conductor connection for functional purposes.
Protection against contact and the IP 20 degree of protection must be ensured by installation.

10.5 NOTES

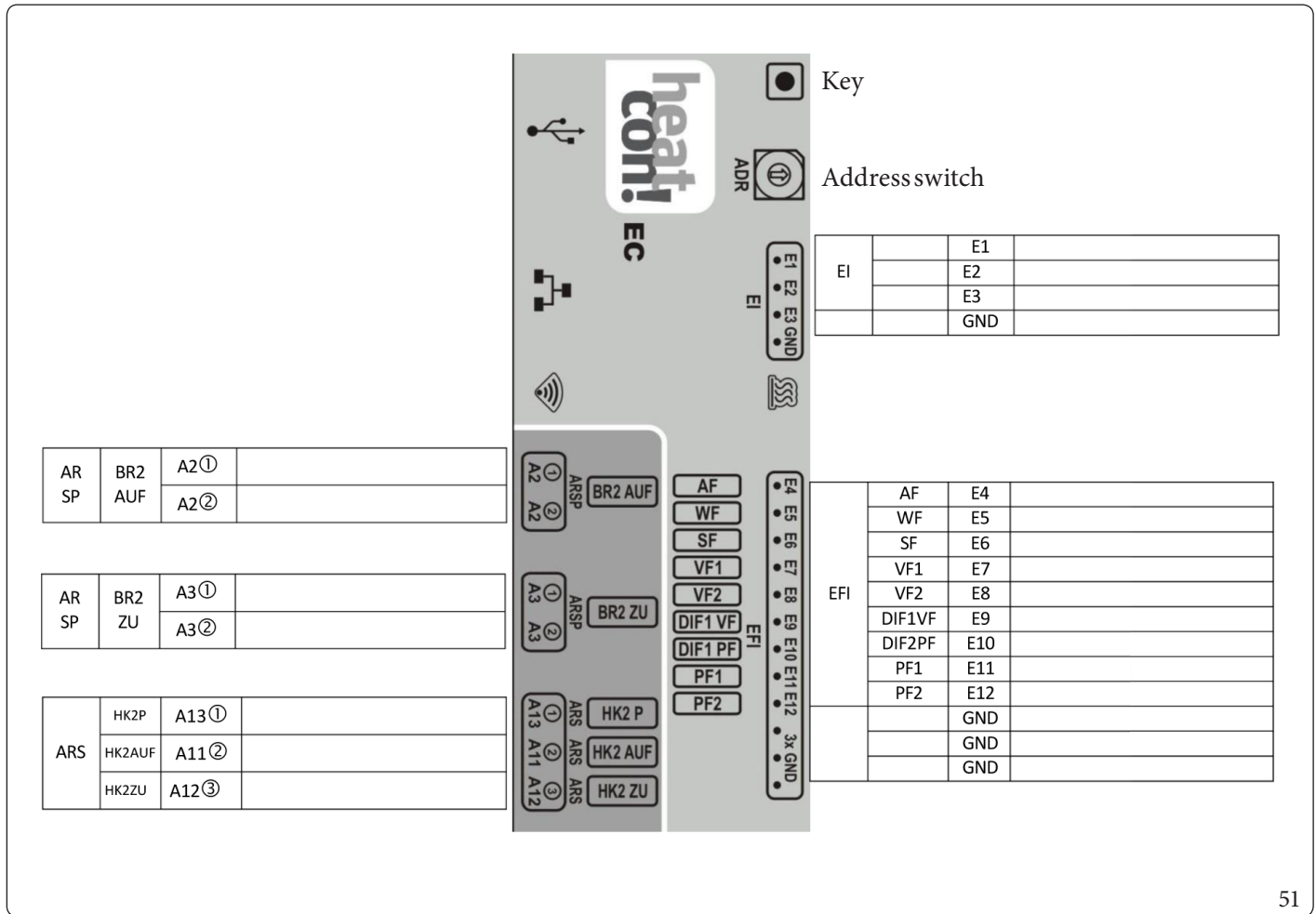

INSTALLER

USER

51

Key (Fig. 51):

- E1 - Input impulses
- EFI - Input sensor impulses
- EFI10V - Input sensor impulse 10V
- EO - Input Optocoupler (operating hours counter)
- ARS - Output relay closer
- ARSP - Output relay closer potential-free
- A10VP - Output 10V PWM (pulse width modulation)
- EEZ Bus - Energy generator bus
- RC - Room thermostat
- MMI - Interface
- EM - Extension Module

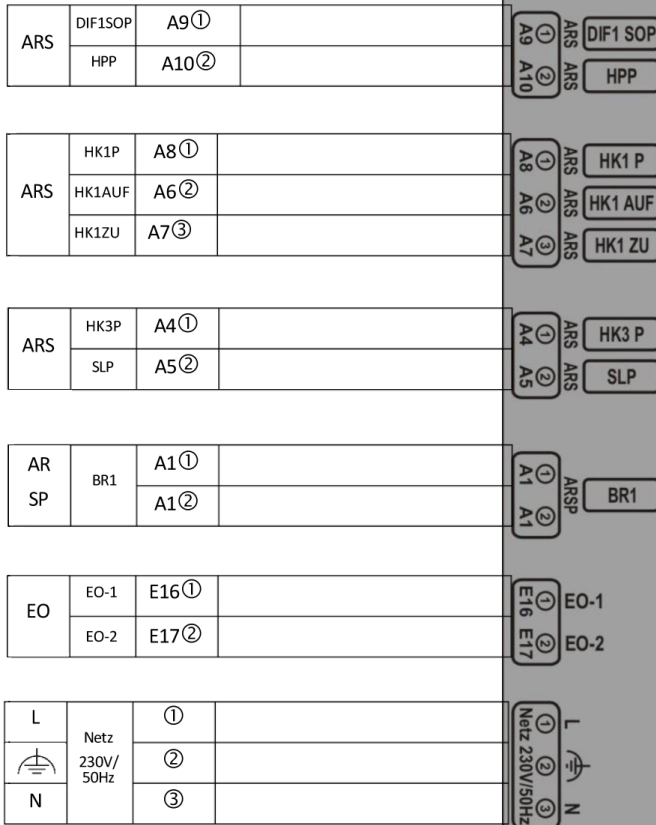

EFI 10V		E13	
		E14	
		E15	
A10 VP		A14	
		A15	
		GND	
EEZ Bus		GND	
		B	
		A	
RC		B	
		A	



Display MMI



Extension Module

Art.-Nr.0481900140

11 EBV - LEARNING



Scan the QR code or visit <https://learning.ebv-gmbh.de>.

INSTALLER

USER

12 SYSTEM DESCRIPTION

12.1 SYSTEM OVERVIEW

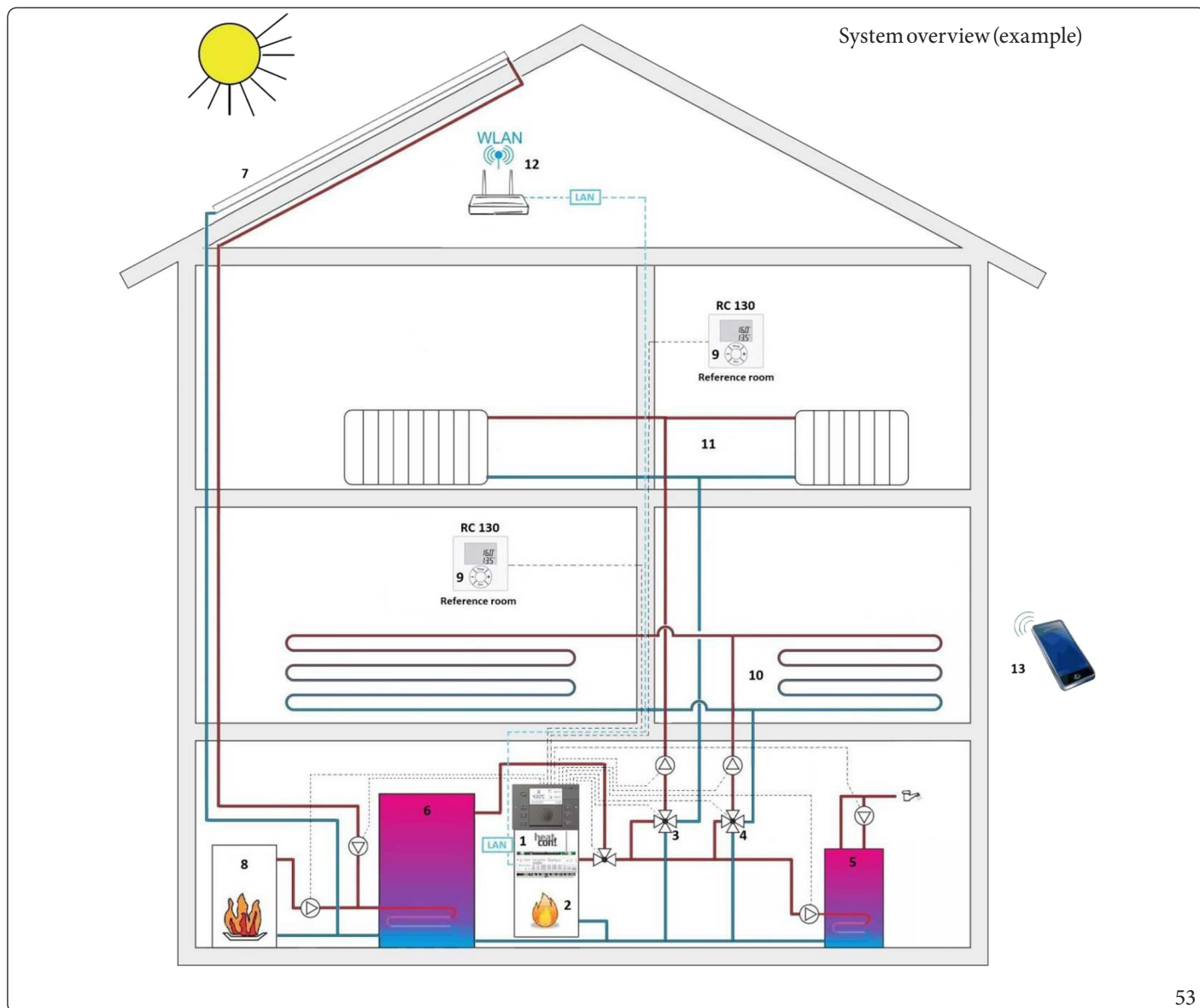

Key (Fig. 53):

- 1 - heatcon! EC
- 2 - Heat source
- 3 - Mixer heating circuit 1
- 4 - Mixer heating circuit 2
- 5 - DHW storage
- 6 - Buffer storage
- 7 - Solar
- 8 - Solid fuel boiler
- 9 - RC 130 (Room sensor)
- 10 - Floor heating
- 11 - Radiator
- 12 - Wi-Fi router (customer-provided)
- 13 - Smartphone/tablet with heatapp! app

12.2 HEATCON! SYSTEM

heatcon! system is a heating controller that is versatile and expandable. The basic unit heatcon! EC 1351 Pro is the central control and regulation unit with Ethernet or WiFi connection for operation via PC and heatapp! app.



Not all functions may be available, as it depends on the configurations.

Even the heatapp! system complete is not available (control of individual rooms is not available from Immergas).

The heatapp! app is available and free (a network connection is required and must be configured by a technician; this may incur additional costs for the Internet connection).

The heatcon! EC can be operated in three ways:

- via heatcon! MMI 200 (without network connection).
- via free heatapp! app (network connection required).



For the application to work correctly, the Technician or Administrator must enable the Rooms to be visible for the User profile.

- via WEB browser (network connection required).



Not available for "user" profile.

13 HEATCON! MMI 200



54

Key (Fig. 54):

- 1 - Button "Emission measurement / manual mode"
- 2 - Button "Scenes/operating modes"
- 3 - Button "Programming"
- 4 - Button "Info"
- 5 - Cover Manufacturer connection
- 6 - Button "Comfort/Economy temperature"
- 7 - Button "Set-back temperature"
- 8 - Button "Hot water daytime temperature"
- 9 - Display
- 10 - Rotary button (press & turn)

The heatcon! MMI is the control unit for the heatcon! System for operation without an WEB browser. The corresponding menus are called up via the buttons.

Navigation through the menus and setting of values is performed using the rotary knob.

At each heatcon! EC a heatcon! MMI can be connected. The assignment is made directly to the desired heatcon! EC.



From APP with "user" profile you cannot view the heatcon! EC 1351 pro settings, which are visible from the heatcon! interface MMI 200.

13.1 BASIC DISPLAY



Key (Fig. 55):

- 1 - Energy generator temperature
- 2 - Date
- 3 - Hot water temperature
- 4 - External temperature
- 5 - Time

After switching on the power supply, the display of the heatcon! MMI shows the basic display. The following temperatures are displayed at the factory:

- Energy generator temperature.
- Hot water temperature.
- Outside temperature.



The temperatures shown in the basic display can be adjusted, see chapter 13.4 “Configuring basic display”).

13.2 MENU NAVIGATION

Operation is via the rotary knob and menu buttons on the heatcon! MMI.

Rotary knob

The rotary knob is used to navigate through the menus and change parameters and values.

Action		Description
Longpress (>3s)		Call up the main menu.
Rotation		Navigation through the menus. Setting parameters and values.
Briefpress (1x)		Selecting menus and parameters. Confirmation of parameter inputs.

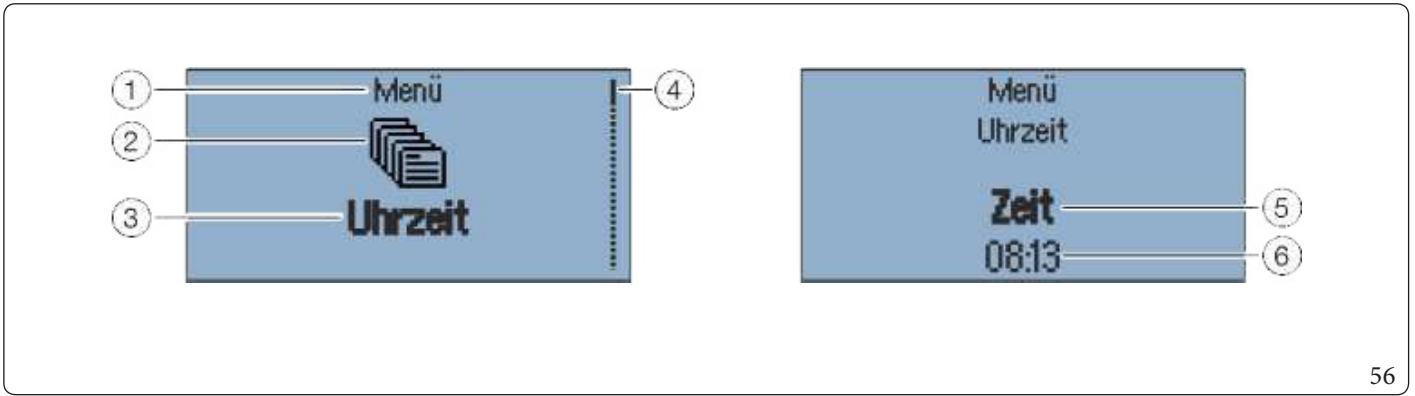

Example Time menu:

Key (Fig. 56):

- 1 - Energy generator temperature
- 2 - Date
- 3 - Hot water temperature
- 4 - External temperature
- 5 - Time

Selecting and changing of menus and parameters

If the scroll bar is displayed in the menu, there are further selection options in the menu. These are navigated through by turning the rotary button.



If menus/parameters are highlighted in bold, they can be selected by pressing the rotary button.



To change parameters, select the parameters highlighted in bold by pressing the rotary button to edit them. Now the value of the parameter is highlighted in bold and can be changed by turning the rotary button.

Press the rotary knob to save the setting.

Speed-dial buttons

Functions are activated/deactivated via the quick selection keys. Certain menus can be called up directly in order to change values quickly.

Key	Description
	Calls the menu "Scenes" and "operation mode".
	Calls the menu "Schedule".
	Calls the menu "information".

Key	Description
	Calls the menu "comfort temperature" and economy temperature".
	Calls the menu "Set-back temperature".
	Calls the menu "hot water".

Advanced key function:

- Function of the Info key

Key	Description
	Within menus, the Info key has a special function. Pressing the info key navigates backwards through the menu levels.

- Function of the "Operating modes and scenes" button.

Key	Description
	Within menus, the operating modes and scenes key has a special function. Pressing the operating modes and scenes key takes you back to the basic view.

13.3 MENU OVERVIEW



The scope of the displayed menus and parameters depends on the system configuration and may differ from the display.

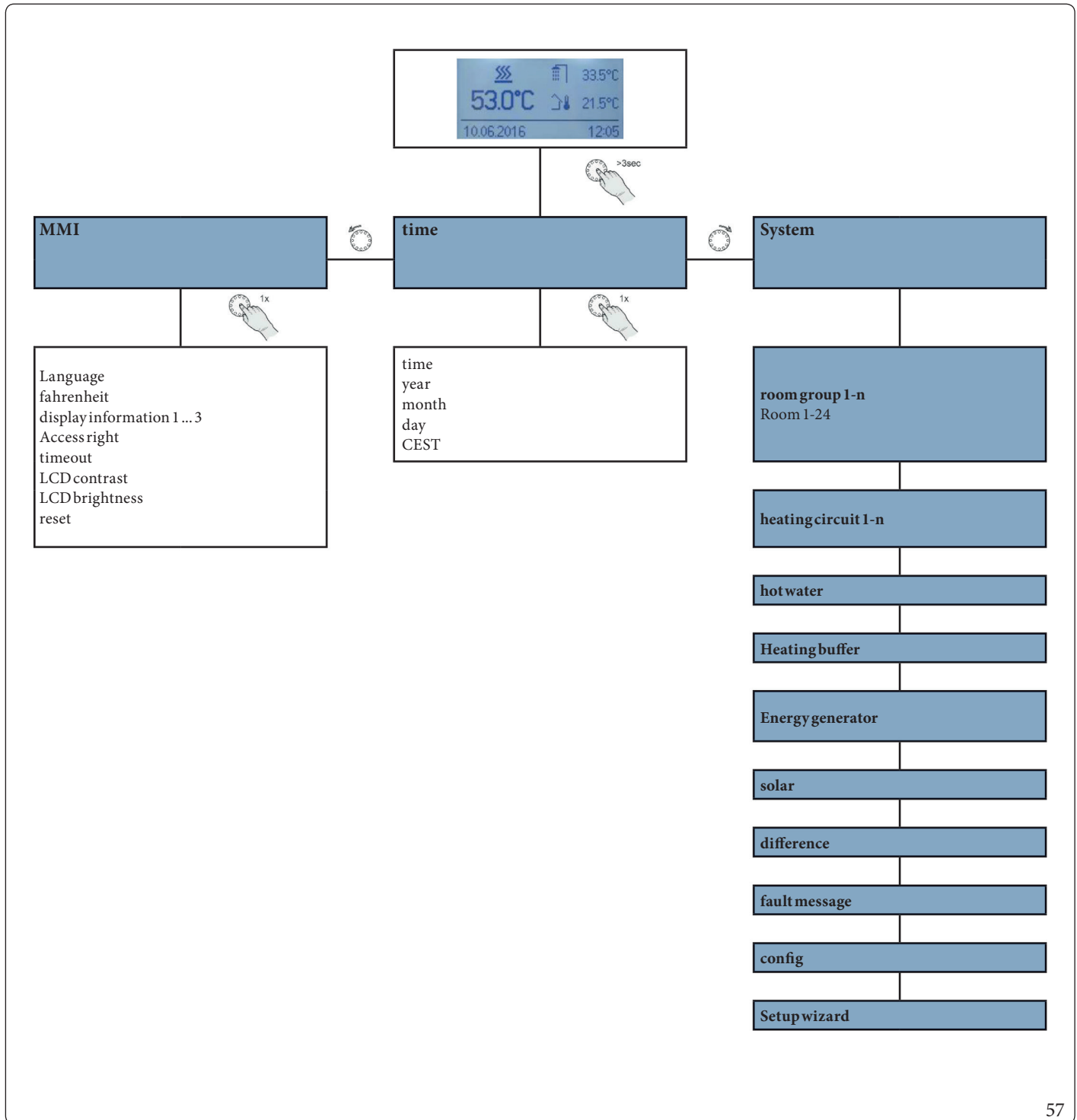

INSTALLER

USER

13.4 CONFIGURING BASIC DISPLAY

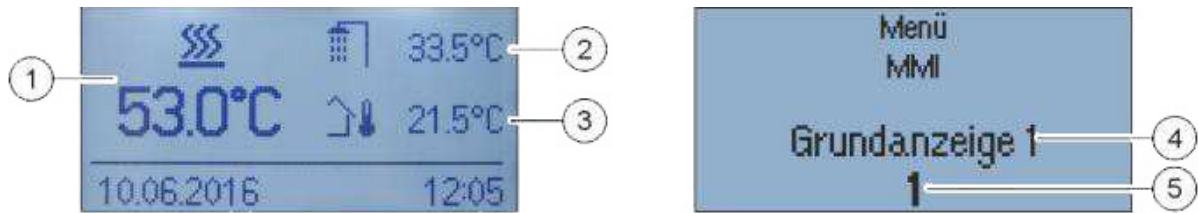

58

Key (Fig. 58):

- 1 - Basic Display Position 1
- 2 - Basic Display Position 2
- 3 - Basic Display Position 3
- 4 - Selected position of the basic display
- 5 - Temperature selection 1...15

The temperatures shown in the basic display can be selected in the "MMI" menu. The basic display has three display positions that can be assigned 15 different temperatures.

Examples can be found in the following table:

Selection	Symbol	Description
OFF	-	No display
1		Energy generator temperature
2		Hot water temperature
3		External temperature
4		Flow temperature heating circuit 1
5		Flow temperature heating circuit 2
6		Flow temperature heating circuit 3 (only modulating pump with FS)
7		Heating buffer temperature
8		Cooling buffer temperature
9,10,11		Flow temperature differential controller 1...3
12		Common flow temperature
13		Return temperature
14		Thermostat switching state
15	-	Not used
16		Energy generator 2 - temperature

13.5 SPEEDBUTTONFUNCTIONS

13.5.1 operation mode and Scenes (Operating modes and scenes)

In the "operation mode and Scenes" menu, the operating mode can be set for the individual room groups (heating circuits), the hot water preparation or for the entire system.

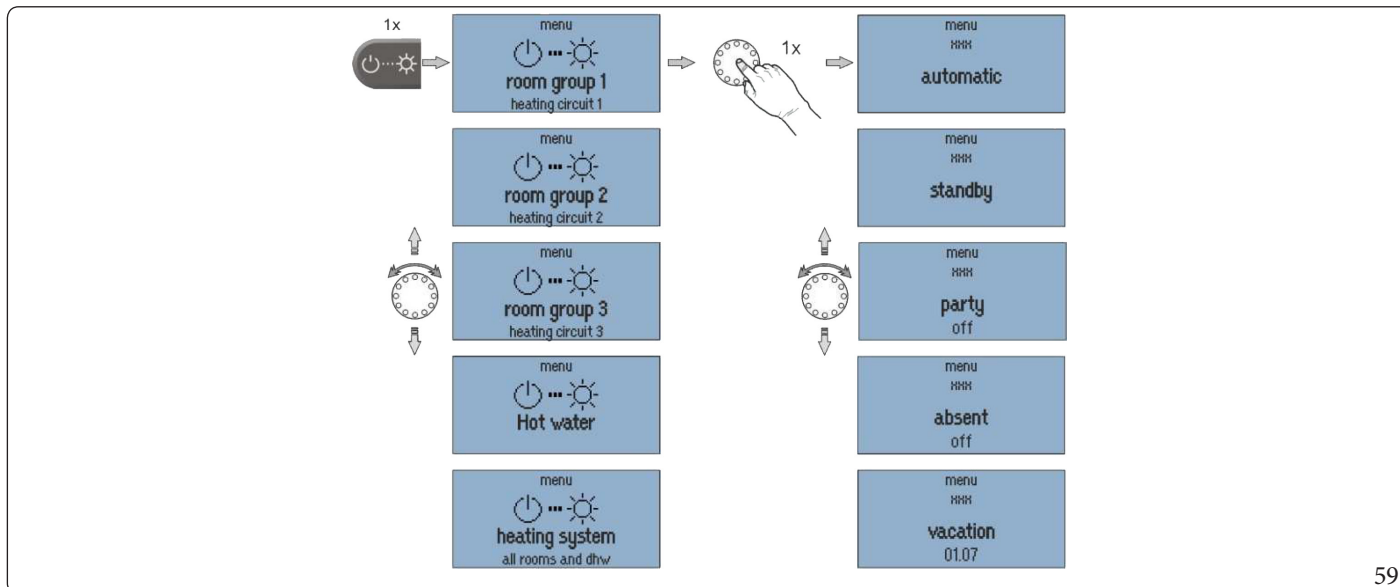

59

Operation mode (display)	Description
automatic	Automatic mode for the selected heating circuit.
standby	Operating mode "standby" sets the room setpoint in the allocated rooms to the set frost protection temperature. In contrast to the vacation scene, the Standby function has no time limit. If the Standby function is activated for all the rooms/room groups, hot water heating is also switched off subject to frost protection.
Party	"Party" operating mode enables the overriding of the set cycle times for the rooms concerned. As long as "Party" operating mode is active, the corresponding comfort temperature applies for the rooms concerned. The operating mode is deactivated after the set runtime elapses. Setting range: Off... + 12 h in steps of 0.5 h
absent	"absent" operating mode enables the overriding of the set cycle times for the rooms concerned. As long as the "Absent" operating mode is active, the corresponding set-back temperature applies for the rooms concerned. The scene is deactivated after the set runtime elapses. Setting range: Off... + 12 h in steps of 0.5 h
Vacation until	The "Vacation until" operating mode is used to set the vacation duration in days. To do so, the vacation duration is entered from the current day in the format DD MM YY (day, month, year) using the rotary wheel. Activation of the vacation function ensures that the temperature does not fall below the minimum temperature (frost protection) of the rooms. Hot water heating is deactivated for the duration of the operating mode. However a set Legionella protection scheme remains active. Setting range: Day/Month/Year adjustable.



Summer operation:

For summer operation (hot water only), the room groups (heating circuits) used must be set to the "standby" operating mode, while the hot water circuit is set to "automatic".

If the assignment of the demand was set to room in the "hot water" - "basic settings" menu, the hot water demand is linked to the room groups. This means that if all room groups are in shutdown ("standby" or "Vacation"), the hot water circuit also switches off in a frost-protected manner.

13.5.2 timerprograms (Timer programs)

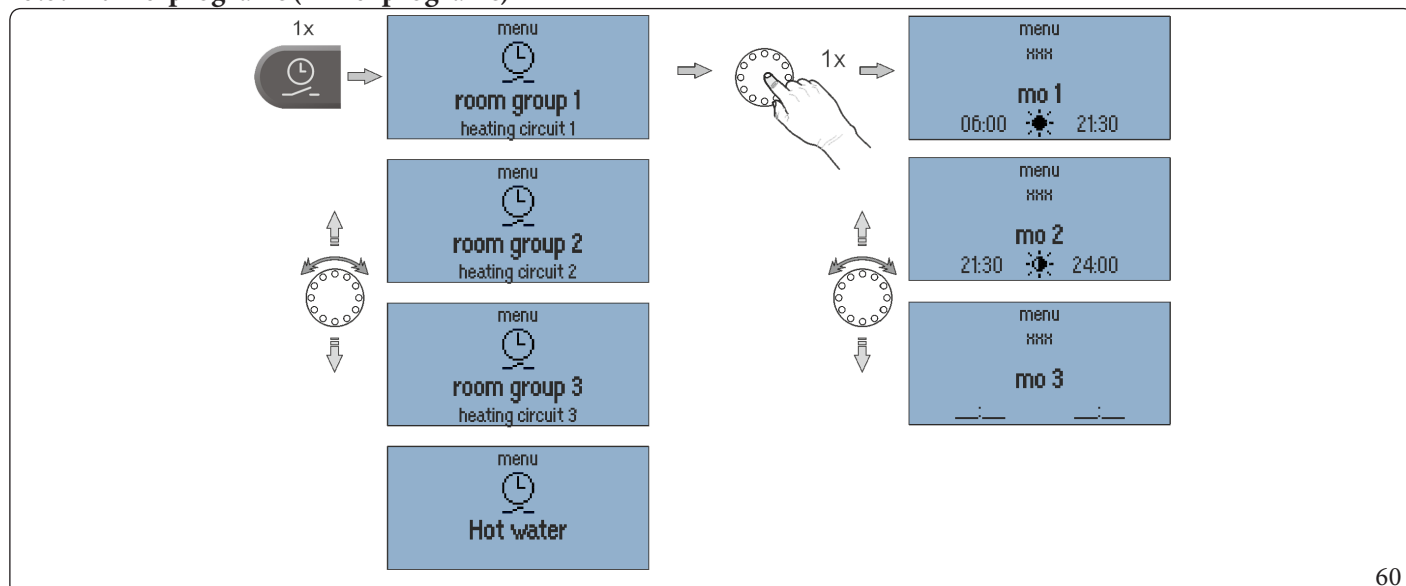

60

In the "timerprograms" menu, individual switching cycles can be programmed for each room group (heating circuit) and the hot water. For programming the switching times a maximum of three switching cycles, each with a switch-on and switch-off time, are available for each weekday. A choice can be made between comfort and economy temperature .

Setting the switching time:

1. Select the desired room group/hot water.
2. Program the switching times for the day in question.
3. If necessary, select comfort and economy temperature .



The default factory program is overwritten as individual switching times are programmed. The individual g can be recorded in the tables in the appendix or backed up by creating a setup log file.

Copy switching times:

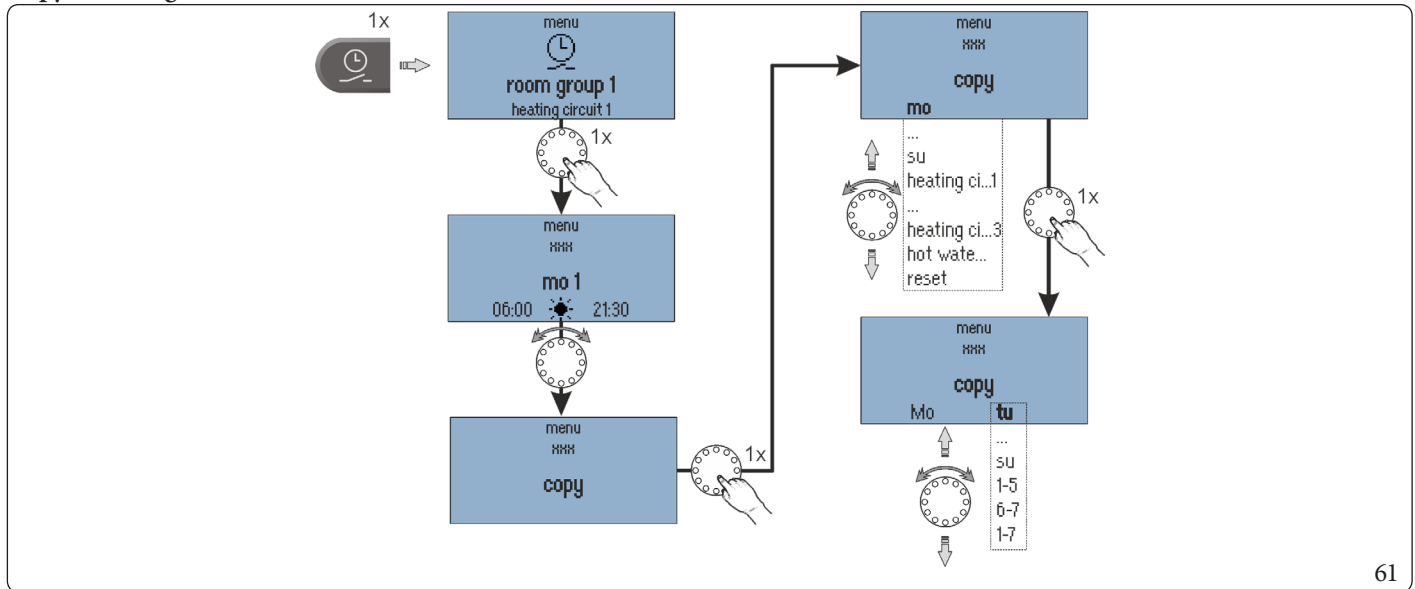

61

The switching cycles of a particular day or of "heating circuit 1 ... n" / "hot water" can be transferred to other days.

1. Select "copy" submenu.
2. Select the desired source to copy.
3. Select the desired target day.

The source switching cycles are transferred to the desired target day.

Source/target (Display)	Description
mo ... su	Day Monday.....Sunday
heating circuit.. 1...n	Switching cycles of heating circuit 1 ... n as source
hot water...	Switching cycles, hot water as source
1-5	Monday to Friday as target
6-7	Saturday to Sunday as target
1-7	Monday to Sunday as target
reset	Reset as the source resets the corresponding target to the factory default program

Vacation:

In addition to activating "Vacation until" program from the current time, it is possible to enter a planned holiday with start and end in the menu timer programs.

13.5.3 information (Information level)

In the "information" menu all available temperatures and system states can be displayed for each room group and each heating circuit.

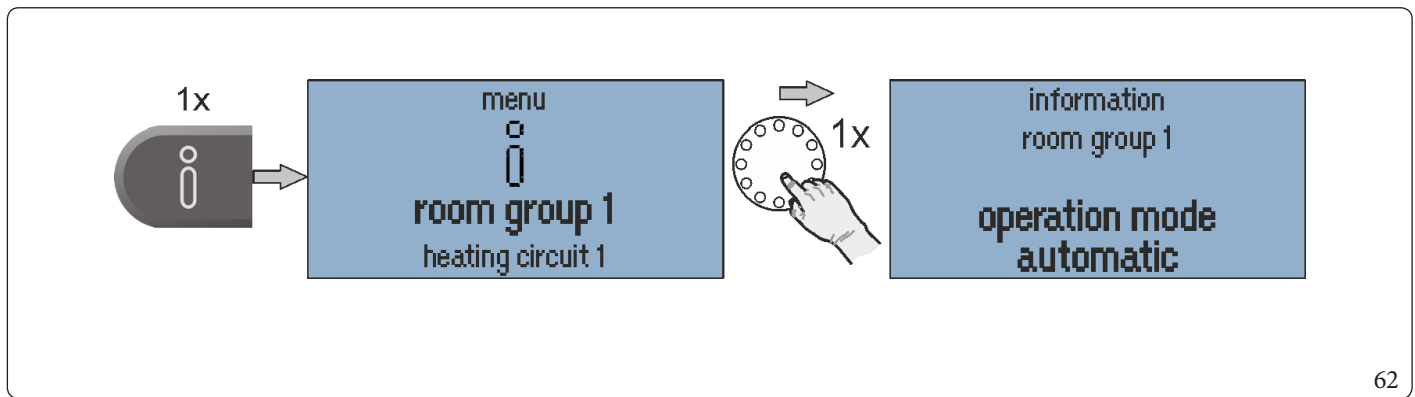

62

 The "information" menu is only used to display values. It cannot be used to change values and parameters.

13.5.4 comfort temperature e economy temperature (Comfort and economy temperature)

The comfort and economy temperature are set for each room group and each heating circuit in the "comfort temperature/ economy temperature" menu

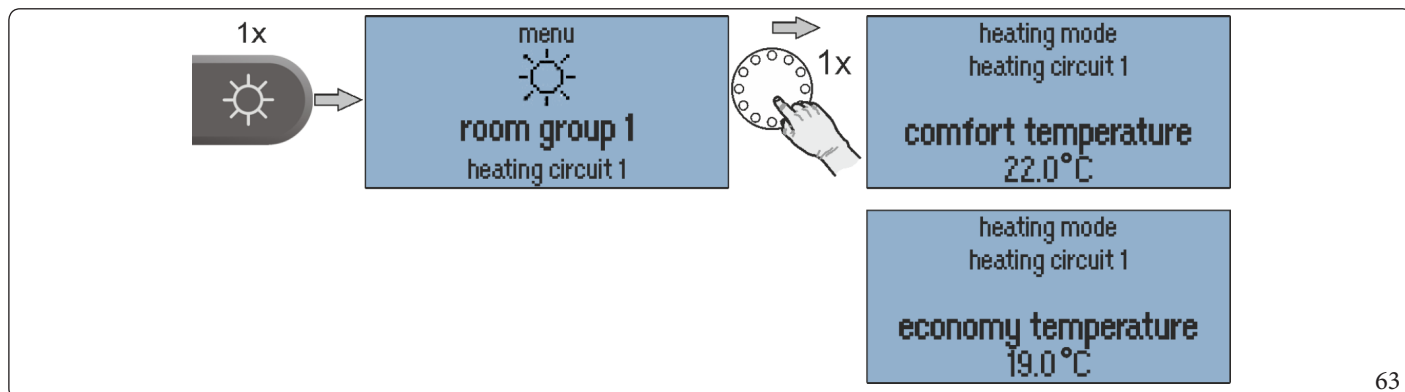

63

Setting the comfort temperature / economy temperature:

1. Call the menu "Daytime temperatures".
2. Select the desired room group or system.
3. Set the desired comfort and economy temperature.

Factory preset		Setting range
comfort temperature:	21°C	economy temperature... 28°C
economy temperature:	20°C	Set-back temperature.. comfort temperature

13.5.5 Set-back temperature (Set-back temperature)

The set-back temperature is set for each room group and each heating circuit in the "Set-back temperature" menu.

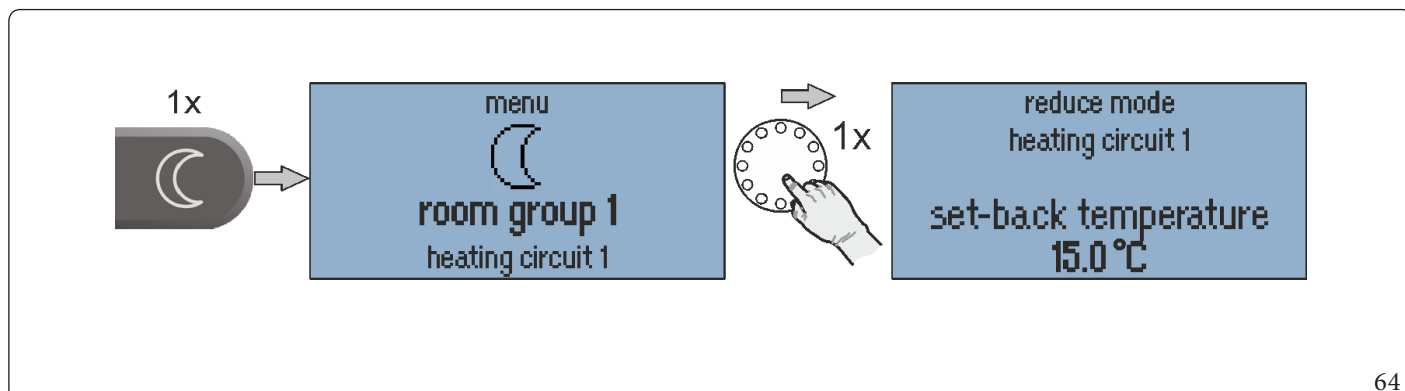

64

Set the Set-back temperature:

1. Calls the menu "Set-back temperature".
2. Select the desired room group or system.
3. Set the desired set-back temperature.

Factory preset		Setting range
Set-back temperature:	18°C	frost protection temperature ... economy temperature

i **room group 1-n/Room 1-24:** The set temperature is valid for the respective heating circuit or room.

System: The set temperature is valid for all heating circuits and rooms together.

The comfort, economy and set-back temperatures for all rooms or room groups as well as the hot water temperature (system) can only be set within the pre-set temperature limits:

- The comfort temperature not less than the economy temperature.
- The economy temperature not above the comfort temperature and not less than the set-back temperature.
- The set-back temperature not above the economy temperature and not less than the frost protection temperature.

The set temperature is the starting value for the individually adjustable temperature settings during the heating cycles (cycle temperatures) in the "programm" menu.

i The division into 1-24 rooms is not available since Immergas does not provide the complete heatapp system! (gateways, heads, ...).

13.5.6 hot water (Hot water)

The hot water day temperature is set in the "hot water" menu.

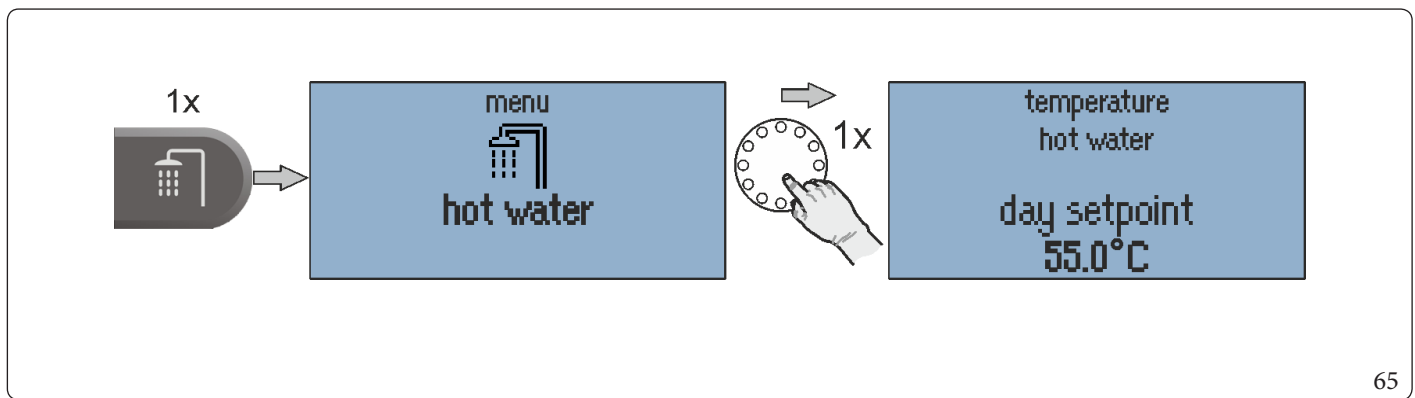

65

Set the hot water day temperature:

1. Calls the menu "hot water".
2. Set the desired hot water daytime temperature.

Factory preset		Setting range
Set-back temperature:	18°C	frost protection temperature ... economy temperature

i The set hot water daytime temperature is the starting value for the individually adjustable temperature settings applied during the standby cycles in the "programm" menu.

14 PARAMETER DESCRIPTION

14.1 MMISYSTEMMENU

The MMI system menus are described below. The factory setting of the parameters is shown in bold.

Menu/Parameter (Display)	Adjustment range	Description
MMI		
Language	DE , GB, FR, IT, NL, PL, ES, TR, RU	MMI language selection: German , English, French, Spanish, Turkish, Dutch, Italian
fahrenheit	off , on	Switching the temperature display to Fahrenheit
display information 1	off, 1...15 (1)	Selection of the temperature values shown in the basic display. See chapter 2.1.
display information 2	off, 1...15 (2)	
display information 3	off, 1...15 (3)	
Access right	0001 ... 9999	Code input for selection of access rights. 0000 (BE → user)
timeout	off, 0,5 ... 2,0 ... 10,0 min	Time setting after which the MMI jumps back to the basic display
LCD contrast	-10 ... 0 ... 10	Contrast setting for the LCD display on the heatcon! MMI
LCD brightness	0 ... 5 ... 10	Setting the brightness of the backlight for the LCD display on the heatcon! MMI
reset	off , set	Resetting the MMI to factory settings.

Menu/Parameter (Display)	Adjustment range	Description
time		
time	00:00 ... 23:59	Setting the system time
year	2013 ... 2099	
month	1 ... 12	
day	1 ... 31	
CEST	off, on	Changeover to summertime

14.2 MENU - HOT WATER

Menu/Parameter (Display)	Adjustment range	Description
... / hot water / timerprograms		
Vacation until	DD:MMDD:MM	Setting the holiday period for hot water preparation.
mo 1...3 tu 1...3 ... su 1...3	00:00 ... 24:00	Setting the switching times for hot water preparation.

14.3 MENU - ROOM GROUP 1 ... N (ROOM 1 ... N)

Menu/Parameter (Display)	Subparameter (display)	Description
... / room group 1 ... n (Room 1 ... 24) / information		
operation mode	Display of the current operation mode.	
	absent	Operating mode / scene "absent" active
	automatic	Operation according to switching time programme active
	Emission	Emission measurement active
	screed	Programme screed drying active
	Manual mode	Manual mode active
	Runtime Magic Wand	Manual temperature specification via magic wand function is active
	Reloading	Room active for an activated hot water recharging (only with single room control)
	Party	Operating mode / scene "Party" active
	standby	Operating mode / scene "standby" active, room / room group frost-protected switched off
	Vacation until	Operating mode / scene "Vacation until" active, room / room group frost-protected switched off
release contact	Activated switching contact. Operating mode according to assigned function	
state	Display of the current status	
	Anti-block protection	Anti-lock protection active for the actuators in the room (only with single room control)
	heating	Regulation to comfort or economy temperature
	Heat limit	Switching off via heating limits function
	Room block	Room not active due to exceeding the set limit temperature (only in connection with a room sensor)
	frost protection	Frost-protected room switched off
	summer operation mode	Room out of operation due to summer economy control
off	Room not active (e.g. in automatic mode setback phases)	
Setpoint	Display of the current Setpoint for the room temperature.	
current temperature	Display of the current temperature of the room (only if room temperature measurement is active).	
outside temperature	Display of the current Outside temperature used for regulation in the room.	
outside temperature long-term	Display of the long-term outside temperature value. This value is determined on the basis of the selected building type (System menu).	
state valve 1 ... 4	(Only for individual room control) Display of the current position of a valve.	
request	Display of the actual Setpoint temperature which is forwarded to the supply of the hot water heating (e.g. heating circuit Setpoint taking into account raising values).	
heating circuit	Display of the current temperature of the required heating circuit.	

Menu/Parameter (Display)	Adjustment range	Description
... / room group 1 ... n / timerprograms (Room 1... 24 / timerprograms)		
Vacation until	DD:MM ... DD:MM	Setting the holiday period for the room / room group.
mo 1...3 tu 1...3 ... su 1...3	00:00 ... 24:00 06:00 ... 22:00	Setting the switching times for the room / room group.

INSTALLER

USER

Menu/Parameter (Display)	Adjustment range	Description
... / room group 1 ... n / basic settings (Room 1... 24 / basic settings)		
request	outside temperature control, room control, constant control	Selection of the requirement for the room/room group.
screed	off, functional heating, laying heating, functional heating, laying heating	Selection of the screed heating program for the room/room group. See also section.
frost protection	off, -20 ... 3 ... 29 °C	Outside temperature setting for activation of the frost protection function for the room/room group.
summer operation mode	off, frost protection ... 20,0 ... 30 °C	Outside temperature setting for activation of summer Operation mode for the room/room group.
frost protection mode	frost protection temperature, Set-back temperature	Selection of the temperature level based on which the frost protection function for the room/room group is to be controlled. Room frost protection deviation control based on the set frost protection temperature or room frost protection deviation control based on the set set-back temperature.
Runtime Magic Wand	off, 0,5 ... 3.0 ... 12.0 h	
name	Alphanumeric, max. 15 characters, no special characters	Enter the name for the room / room group.

Menu/Parameter (Display)	Adjustment range	Description
... / room group 1 ... n / room settings (Room 1... 24 / room settings)		
maximum temperature	comfort temperature 28,0 °C	Setting the maximum room Setpoint temperature for the room.
comfort temperature	economy temperature... 21.0... 28,0 °C	Room Setpoint temperature setting for heating operation.
economy temperature	Set-back temperature... 20,0 °C... comfort temperature	Setting of the reduced room Setpoint temperature for heating operation.
Set-back temperature	Antifreeze protection temperature ... 18,0 °C... economy temperature	Room Setpoint temperature setting for setback operation.
frost protection temperature	4.0 ... 16.0 °C... Set-back temperature	Room Setpoint temperature setting for frost protection operation.
Switch on optimisation	off , 0,5... 8.0 h	Start time advance setting dependent on the outside temperature.
boost offset	0,5 ... 2,0 ... 5,0 K	Increase setting of the room Setpoint temperature if Boost scene is activated in the heatapp! app.

Menu/Parameter (Display)	Adjustment range	Description
... / room group 1 ... n / heating mode (Room 1... 24 / heating mode)		
set-back mode	standby, central heating	Selection of the operating mode for setback operation. Standby - frost-protected switch-off ECO Heating - set setback temperature AbS
Frost protection cycle	off , 0,5... 360,0 Min	Selection of the operation mode for the frost protection function for the room/room group. Off: Permanent system frost protection, Time: Cycle time of the system frost protection.
heating curve	off, 0,5 ... 1,00 ... 3,5	Setting the slope of the heating characteristic for Outside temperature control.
Heating system	1.0 ... 10.0	Standard values for setting: Underfloor heating system: 1.10; Radiator: 1,30; Convector: 1.40; Air conditioning > 2.00.
adaption	off , on	Activation of the automatic parameter adaptation for the heating curve.
heat limit	off , 0,5 ... 40 K	Heat limit setting for the room.
increase of request	-5,0 ... 0,0 ... 20 K	Requirement-boost setting for the room. Increase to the Setpoint for passing on to the heating circuit.

Menu/Parameter (Display)	Adjustment range	Description
... / rooms 1 ... 24 / reset		
room group 1 ... n / reset		
reset	off, set	Resetting the parameters in the "Room / room group" menu to the factory setting, according to the access authorisation.

15 HEATCON! RC 130



66

The **RC 130** room thermostat (zone manager kit) for the room group, and detects the room temperature for the **heatcon! system**. The temporary desired temperature can be set with the + or - button. The change of the desired temperature applies once until the switching time change, but at least for 3 hours.

The **RC 130** is **integrated into the heatcon! system** by means of addressing and can be assigned to a **heatcon! Ec** and a room group (1 of max. 5) as reference room control or, in the case of single room control, to a room (1 of max. 24).



Single room control is not possible, as Immergas does not provide the heatapp! system.

INSTALLER

USER

16 HEATCON! ERROR CODES

A pending error is shown alternately with the basic display in the MMI display.

Example: **AF4-1** = Meaning → Outdoor sensor **AF** / Input E4 / Short circuited **1**

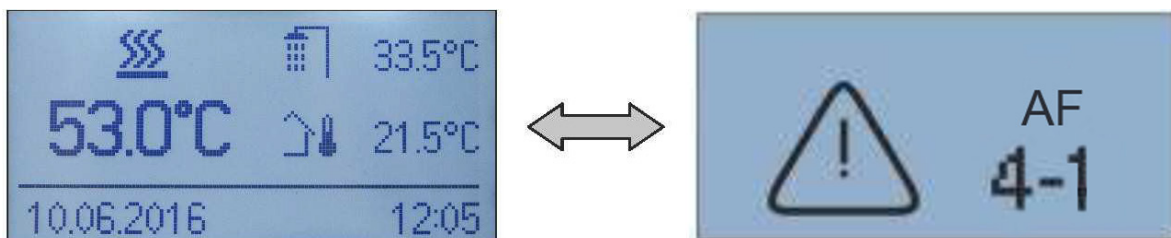

Error display/ Error message		Error location		Error type
Error - Code	Error number			
W(n)-	FA-specific	Machine Warning	Machine address 0 ... n	Warning message machine
B(n)-	FA-specific	Machine Blocking	Machine address 0 ... n	Blocking message machine
E(n)-	FA-specific	Machine Blocking	Machine address 0 ... n	Locking message automatic
4 ... 15	0	Sensor	Input E4 ... E15	Interruption
	1			Short circuit
21 ... 24	0	Sensor	EM-1 Input E1 ... E4 e.g.: (EM-1/E1=error code 21)	Interruption
	1			Short circuit
31 ... 34	0	Sensor	EM-2 Input E1 ... E4 e.g.: (EM2/E1=error code 31)	Interruption
	1			Short circuit
33	5	Energy generator	Exhaust gas monitoring	Exhaust blocking
	6			Exhaust interlock
49	4	Energy generator 2		Setpoint not reached
50	3	Energy generator		Starter identification: GEN does not switch on
50	4	Energy generator 1		Setpoint not reached
51	4	Hot water		Setpoint not reached
53 ... 76	5	Room / group	Room 1 ... 24 e.g. (Room 1 = error code 53) (Room 2 = error code 54) etc.	Room temperature not reached
	20			Heating supply not available
	21			Cooling supply not available
70	6	Bus	Machine	Malfunction connection to the vending machine
71	6	Bus	EM-1	Fault connection to EM-1
72	6	Bus	EM-2	Fault connection to EM-2
81 ... 85	4	Heating circuit	Heating circuit 1 ... 5 e.g.: (heating circuit 1=error code 81)	Setpoint not reached
90	0	Fault message	Fault message input	System message (optional)

17 SWITCHING TIMES

Hotwater / room group	Day	Timer program 1	Timer program 2	Timer program 3
	Mo			
	Tue			
	Wed			
	Thu			
	Fri			
	Sat			
	Sun			
	Mo			
	Tue			
	Wed			
	Thu			
	Fri			
	Sat			
	Sun			
	Mo			
	Tue			
	Wed			
	Thu			
	Fri			
	Sat			
	Sun			
	Mo			
	Tue			
	Wed			
	Thu			
	Fri			
	Sat			
	Sun			
	Mo			
	Tue			
	Wed			
	Thu			
	Fri			
	Sat			
	Sun			
	Mo			
	Tue			
	Wed			
	Thu			
	Fri			
	Sat			
	Sun			

INSTALLER

USER

18 HEATCON / HEATAPP SYSTEM



The heatapp! system complete is not provided. The following applies to the heatapp! app and related adjustment for a group of rooms (Room group).

18.1 OPERATION VIA APP



The APP is available for Tablets and Smartphones, with Android or iOS system.

18.1.1 Starting the app and logging on to the system

App home screen (the following screens are typical of the tablet application, which differ slightly from those of the smartphone application).

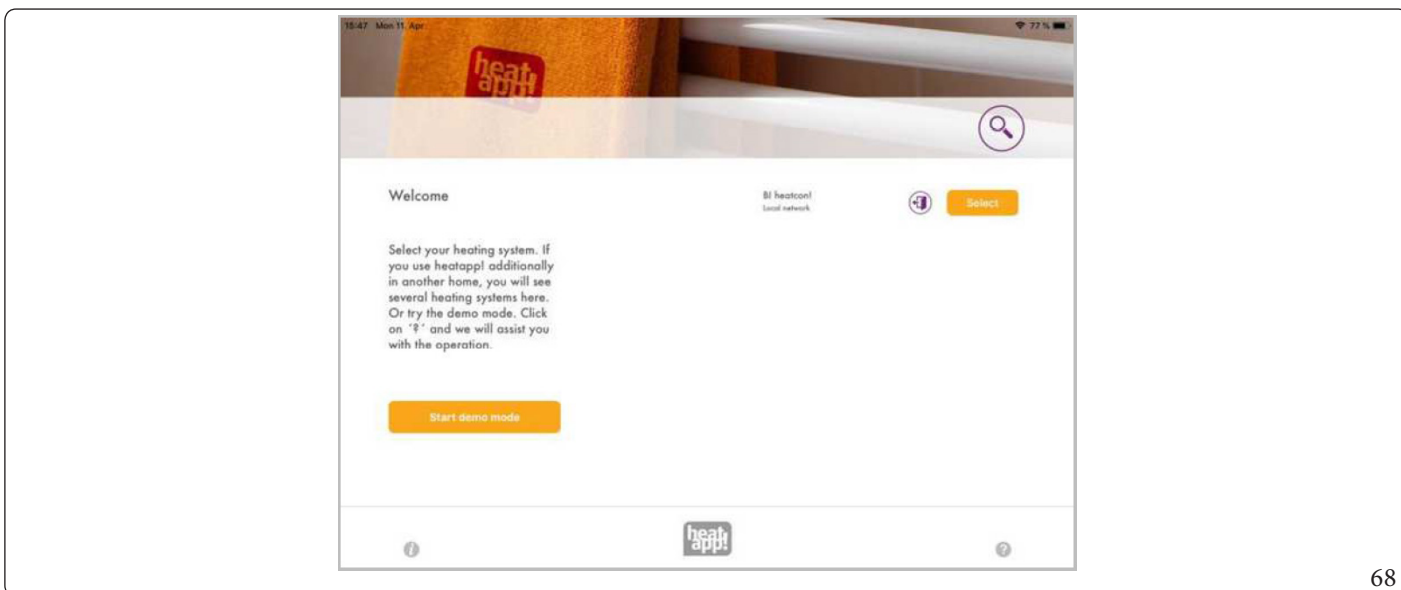

68



For the first login to your heatcon! system, it is necessary that your operating device (tablet or smartphone) is in the same network as your heatcon! system.

The heating system is listed with its name registered with the facility during system/installation configuration.

Directly under the name, you can see whether the heating system is in the same network "local network" or whether the connection to the heating system is established via "Internet" **heatapp! connect**.

1. Tap on the desired heating system.
2. The "Logon" dialogue box is displayed. Enter your user name (2, fig. 69) and password (3, fig. 69).
3. Confirm the entry by tapping the button (4, fig. 69) "Log in". Use the button (1, fig. 69) "Back" to return to the start menu without logging in.
4. After successful login, the "Home screen" is displayed.

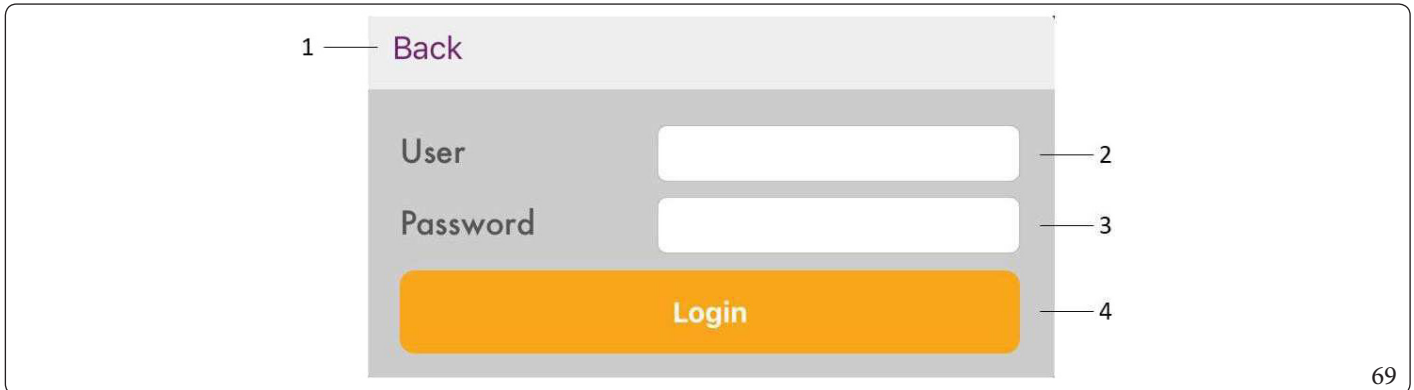

After logging in, the app saves the current user and password. As long as the current user is logged in, there is no need to re-enter the user name and password.

You can log out of the corresponding system via the button .

18.2 THE "HOMESCREEN"

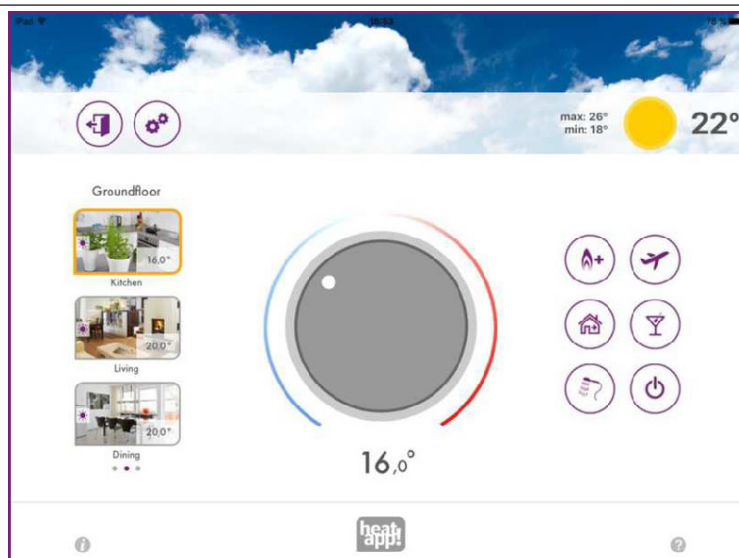

70

The "Home screen" shows an overview of the rooms/room groups created, the direct option to adjust the temperature via the rotary wheel and to activate and deactivate scenes.

In the local network, the **heatapp! app** checks whether the system software is up to date after selecting the heatapp! system. If there is an update, you will receive a message "**Update available.**".

The "now" button takes you to the system update page of **heatapp! Gateway (not supplied)** or **heatcon!**. With the button "later" you will be informed again in 5 days about the possible update.

Leaving the "Home" screen.

Tap the symbol  to return to the start screen.









Calling up the settings.



















Tap the icon  to access the settings.

Weather display.

Heatapp! displays the weather data of the system location entered in the **heatcon!** menu. The external temperature read by the external sensor connected to the heatcon! EC is displayed or the external temperature read by the external sensor connected to the single or master boiler via BUS (Victrix Pro V2). The min/max values for the current day are also displayed. If no outdoor sensor is detected, the Outside temperature value predicted by the weather service for the system location is displayed.

18.3 SYMBOLS IN THE ROOMS

Symbol	Operating mode energy without generator connection	Operating mode with energy generator connection
	Automatic mode Comfort temperature. Heating mode is active after the set switching time .	Automatic mode Comfort temperature. Heating mode is active after the set switching time . State: Current temperature \geq Setpoint = No heat demand present
	-	Automatic mode Comfort temperature. Heating mode is active after the set switching time . State: Current temperature $<$ Setpoint = No heat demand present
	Automatic mode economy temperature. Heating mode is active after the set switching time .	Automatic mode economy temperature. Heating mode is active after the set switching time . State: Current temperature \geq Setpoint = No heat demand present
	-	Automatic mode economy temperature. Heating mode is active after the set switching time . State: Current temperature $<$ Setpoint = heat demand present.
	Automatic mode lowering. The lowering mode is active after the set switching time .	Automatic mode lowering. The lowering mode is active after the set switching time . State: Current temperature \geq Setpoint = No heat demand present
	-	Automatic mode lowering. The lowering mode is active after the set switching time . State: Current temperature $<$ Setpoint = heat demand present.
	Heating or cooling operation takes place at the set desired temperature until the end of the switching time, but at least for 3 hours.	Heating or cooling operation takes place at the set desired temperature until the end of the switching time, but at least for 3 hours. State: Current temperature \geq Setpoint = No heat demand present
	-	Heating or cooling operation takes place at the set desired temperature until the end of the switching time, but at least for 3 hours. State: Current temperature $<$ setpoint temperature = heat demand present.
	Standby function. With the standby function, the selected rooms are switched off in a frost-protected manner. In contrast to the Vacation scene, the standby function has no time limit.	Standby function. With the standby function, the selected rooms are switched off in a frost-protected manner. In contrast to the Vacation scene, the standby function has no time limit. State: Current temperature \geq Setpoint = No heat demand present

Symbol	Operating mode energy without generator connection	Operating mode with energy generator connection
	-	Standby function. With the standby function, the selected rooms are switched off in a frost-protected manner. In contrast to the Vacation scene, the standby function has no time limit. State: Current temperature < Setpoint = heat demand present.
	Window closed. Regulation according to the set desired temperature.	Window closed. Regulation according to the set desired temperature.
	Window open. Control takes place according to the parameter set in the heatapp! Profi > Room menu	Window open. Control takes place according to the parameter set in the heatapp! Profi > Room menu.
	Summer shut-off, shut-off of the demand when the set Outside temperature value is exceeded.	Summer shut-off, shut-off of the demand when the set Outside temperature value is exceeded.
	Room cooling manually active. The cooling operation takes place according to the set parameter in automatic mode after the set switching time. This is a repeating temperature according to the switching time programme.	Room cooling manually active. The cooling operation takes place according to the set parameter in automatic mode after the set switching time. This is a repeating temperature according to the switching time programme.
	Blocking of the heating request, due to active manual cooling. To operate the heating request, manual cooling must be deactivated under Settings > Room the "Global Cooling" via the symbol  .	Blocking of the heating request, due to active manual cooling. To operate the heating request, manual cooling must be deactivated under Settings > Room the "Global Cooling" via the symbol  .
	Scene Boost active for the room according to preset parameters.	Scene Boost active for the room according to preset parameters. State: Current temperature =/> Setpoint = No heat demand present
	-	Scene Boost active for the room according to preset parameters. State: Current temperature < Setpoint = heat demand present.
	Scene go active for the space.	Scene go active for the space. State: Current temperature =/> Setpoint = No heat demand present
	-	Scene go active for the space. State: Current temperature < Setpoint = heat demand present.
	Scene holiday for the room active.	Scene holiday for the room active. State: Current temperature =/> Setpoint = No heat demand present
	-	Scene holiday for the room active. State: Current temperature < Setpoint = heat demand present.
	Scene Party for the room active.	Scene Party for the room active. State: Current temperature =/> Setpoint = No heat demand present
	-	Scene Party for the room active. State: Current temperature < Setpoint = heat demand present.
	Scene Shower for the room active.	Scene Shower for the room active. State: Current temperature =/> Setpoint = No heat demand present
	-	Scene Shower for the room active. State: Current temperature < Setpoint = heat demand present.

18.4 TEMPERATURE SETTING BY MEANS OF ROTARY WHEEL

The temperature for the currently selected room is temporarily set via the rotary wheel by "tapping and turning". This desired temperature is marked in the room picture with the magic wand. It is valid until the end of the switching time, but at least for a time that can be set in professional mode.

The operator can reduce the sensitivity of the rotary wheel by moving the finger outwards from the rotary wheel without putting it down. The sensitivity decreases as the distance from the wheel increases.

The set temperature is displayed under the rotary wheel.

When connecting the heatapp! to the energy generator the deviation of the current room temperature from the set temperature is displayed via the orange halo. If the current room temperature corresponds to the set temperature, the halo also disappears.

The lower limit of the adjustable temperature is determined by the setback temperature specified for the room. The upper limit of the adjustable temperature is fixed at 28.0 °C.



The temperature set on the rotary wheel overrides the currently active operating mode of the selected room (comfort temperature / economy temperature / setback temperature).

If the operating mode is changed by a set switching time, the temperature set on the rotary knob is also reset to the value specified in the switching times for the comfort, economy or setback temperature.

However, the temperature set on the rotary knob is valid for at least three hours, the reset by the switching time is then carried out correspondingly later.

18.4.1 Use of scenes

Scenes can be used to superimpose the set switching times and temperatures for the selected running time of the scenes.

Scenes are assigned to individual rooms (see also chapter See "Scene Edit").

By tapping the scene symbols, you activate scenes for the assigned rooms. This opens the input dialogue of the selected scene. In this dialogue, the rooms can be assigned and the respective parameters of the scene can be set.

The running time of the scene is set via a slider in hours, days or, in the case of the shower scene, the start of the scene.

All scenes can be stopped at any time by tapping the Stop button again.



Activated scenes are highlighted orange.



Scene "boost" (Boost)

The "boost" scene enables the comfort temperature to be reached quickly in the assigned rooms. When activated, the comfort temperature + a fixed temporary increase should heat the rooms as quickly as possible.

The duration of the function is defined or can be made visible by pressing the symbol again.

The running time of the scene can be set in 30-minute steps up to a maximum of 120 minutes.



Scene "Shower" (Showers)

Hot water is normally heated according to the set switching times. If hot water is required outside the set switching times at a certain time, the "Shower" scene can be activated.

Unlike the other scenes, long taps are not used here to set the running time of the scene, but the start time of the scene in steps of 15 minutes.

The duration of the scene is preset to 1 hour.

If the "Shower" scene is activated, the hot water tank is heated to the set target temperature from the start time. In addition, the rooms assigned to the scene are heated to the comfort temperature.

Example:

Normally, there is no hot water production after 22:00. However, hot water is needed for showering at 2:00 (e.g. due to a flight).

When setting the start time for the scene, the time that the heating system needs to heat up the hot water tank should be taken into account.

So the start time of the scene is set to 1:30 and the scene is activated.

Hot water preparation thus starts at 1:30 and the assigned rooms are heated to the comfort temperature.



The time required to heat up the hot water tank depends on the respective heating system and must be determined anew for each installation.

- The shower scene is only available when the heat generator is connected via the bus systems Open Therm, T2B.



Scene "Party" (Party)

The "Party" scene allows the switching times set for the assigned rooms to be superimposed.

As long as the "Party" scene is active, the corresponding comfort temperature applies to the assigned rooms. The scene is deactivated after the set runtime has elapsed. The running time of the scene can be set in steps from one hour to a maximum of 12 hours.

Example:

Normally, the system switches to setback mode at 22:00. But today there is a party that is expected to last until 0:00.

It is now 18:00, so the running time of the scene is now set to 6 hours.

The comfort temperature of the assigned rooms is now set from 18:00 + 6 hours = 0:00.



Scene "Walk"

The "Walk" scene allows the switching times set for the assigned rooms to be superimposed.

As long as the "Walking" scene is active, the setback temperature applies to the assigned rooms. The scene is deactivated after the set runtime has elapsed.

The running time of the scene can be set in steps from one hour to a maximum of 6 hours.



Scene "Vacation until" (Vacation)

The "Vacation until" scene enables the setting of the holiday duration in days. The holiday duration is entered in days from the current day via the slider. Activating the holiday function ensures that the temperature in the rooms does not fall below the minimum temperature (frost protection).

In contrast to the Walk scene (setback temperature), in the Vacation scene the temperature is set to the frost protection temperature. The active holiday rooms can no longer be operated with the rotary wheel.

Hot water preparation (only with hot water connection via the bus systems Open Therm, T2B or 485) is deactivated for the duration of the scene. However, a set legionella protection remains active.

The running time of the scene can be set by the day up to a maximum of 30 days.



Scene "standby" (Standby)

With the "standby" function, the selected rooms are switched off in a frost-protected manner. In contrast to the "Vacation until" scene, function "standby", the Standby function has no time limit.

Note the setting for switching off the hot water preparation. In the Profi menu of the **heatapp!**, you can choose between room shut-off and operating mode shut-off for hot water preparation.

If the switch-off for hot water preparation is set to "Room", the hot water preparation is also deactivated if all rooms are in "standby mode. If a room remains active, hot water preparation takes place according to the switching times.

If the switch-off of the water heating is set to "operation mode", it remains in automatic mode even in standby mode and the control takes place according to the switching times, even if all rooms are in standby. The "standby" function corresponds to the "summer operation mode" operating mode.

18.4.2 The menu "Settings"

The "Settings" operating level is used to access advanced functions.

sono disponibili per tutti gli utenti. "My profile", "Design", "Cycle time" and "Live View" are available for all users.

Professionals and administrators also have the additional menu items "rooms", "Users", "Devices", "Scene", "System" and "Gateway" at their disposal.



Menu "Settings"

Tapping the cogwheel symbol takes you to the settings level. On the left side are the individual menu icons. On the right-hand side you can edit the individual menu items.

Edit user profile

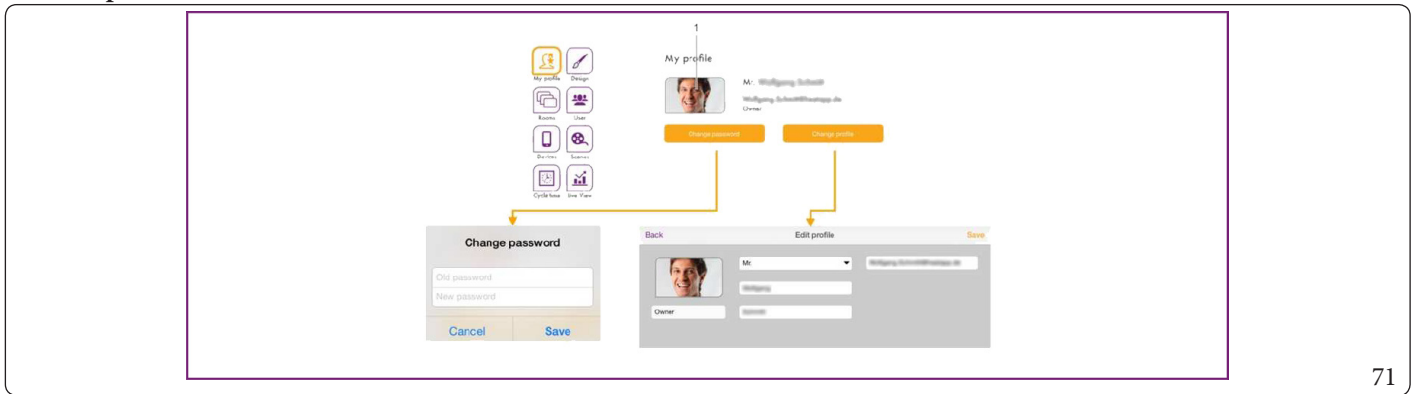

71

In the "My profile" area, you can edit the profile of the currently logged-in user.

Profile picture change

Via button you can assign a profile picture to the user from the gallery or via the camera of the device.

Password change

Tap the "Change Password" button to change the password of the currently logged-in user.

Edit user profile

Tap the "Edit Profile" button to change the user data of the currently logged-in user. The user role cannot be changed.

App design Customise

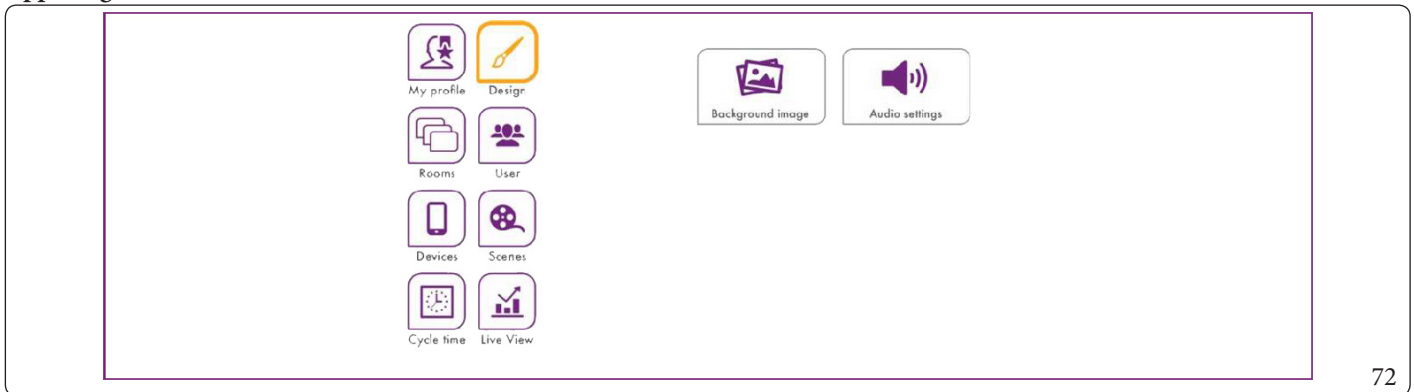

72

In the "Design" area, you can edit the design and audio settings of the app.

Change background image

Tap the "Change wallpaper" button to change the background image of the app. You can select a wallpaper from the gallery or create one directly via the device's camera (device-dependent).

Alternatively, you can select one of the four supplied **heatapp!** standard wallpapers.

Audio settings

Tap the "Audio settings" button to switch the acoustic feedback for the rotary wheel on or off.

Rooms and space groups

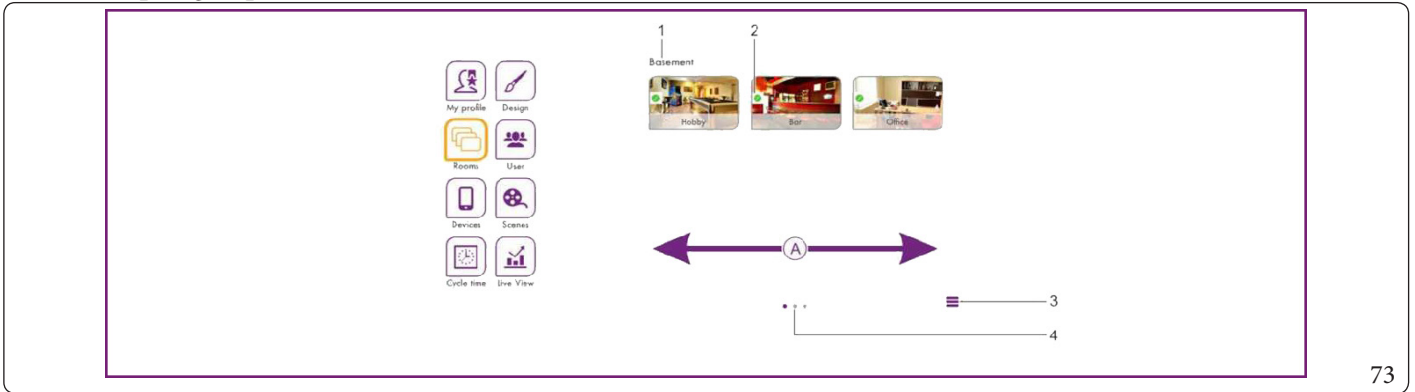

73

Key (Fig. 73):

- 1 - Name of the room group
- 2 - "Room State" symbol
- 3 - Edit room groups icon
- 4 - Number of room groups



The available rooms are created by the expert during commissioning. The names of the rooms are also defined.

When used for the first time, all rooms are displayed in this view. No room groups have been created yet (to create room groups see chapter "Rooms and space groups").

- Swipe "A" horizontally to switch through the room groups.
- Rooms are moved between the room groups by drag & drop.
- Rooms are selected for editing by simply tapping on them.
- Small symbols in the room images indicate the State of the rooms.

Symbol	Status
	Room in operation, everything in order.
	Room undefined, no radio components assigned.
	Malfunction of a wireless component in the room (e.g. battery room sensor empty).

Room edit

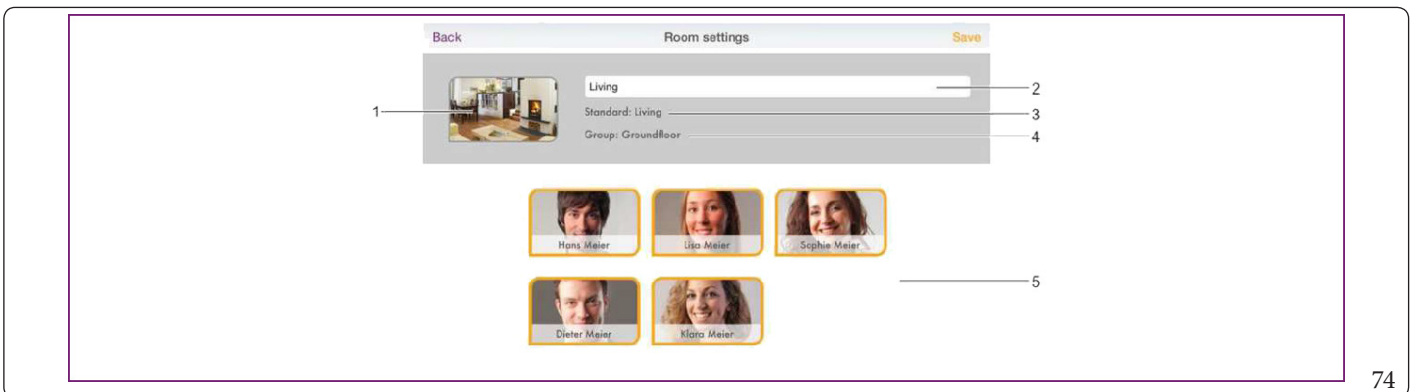

74

Key (Fig. 74):

- 1 - Spatial image
- 2 - Room name (displayed name) (only available via heatapp! system (not supplied))
- 3 - Default name (set during commissioning)
- 4 - Room group
- 5 - User list

Here you can change the displayed room name, assign a room image to the room and assign the room to specific users.

1. Tap on a room in the "Rooms" area. The dialogue window "Room settings" is displayed. Make the desired setting according to the following description.
2. Tap on "Save" to apply the settings for the room. Tapping on "Back" discards the changes.

Change displayed room name

To rename a room, tap on the room name and enter the desired name. Only the displayed room name is changed. This change does not affect the default name assigned in the **heatapp!** setup wizard.

The default name can only be changed in professional mode (Settings / System / Professional) of the **heatapp!** or by going through the setup wizard again.



If the default name is to be used as the displayed name, delete the name in the input field. The input field is then automatically preset with the default name of the room.

Change room images

To change the room picture, tap on the room picture. You can create a picture using the unit's camera or select one from the gallery. Alternatively, you can select one of the supplied room pictures.

User allocate

The users already created are displayed.

Users who are authorised to control this room are shown with an orange frame. Users who are not authorised to control this room are shown without a frame. By tapping on the respective user, the rights for the room in question can be granted and revoked.

Delete rooms

Deleting rooms is only possible via the setup wizard. The deletion process always affects the selected room and all subsequent rooms that have already been created.

If several rooms have already been created, it is not possible to delete a single room between the created rooms.

Room group create

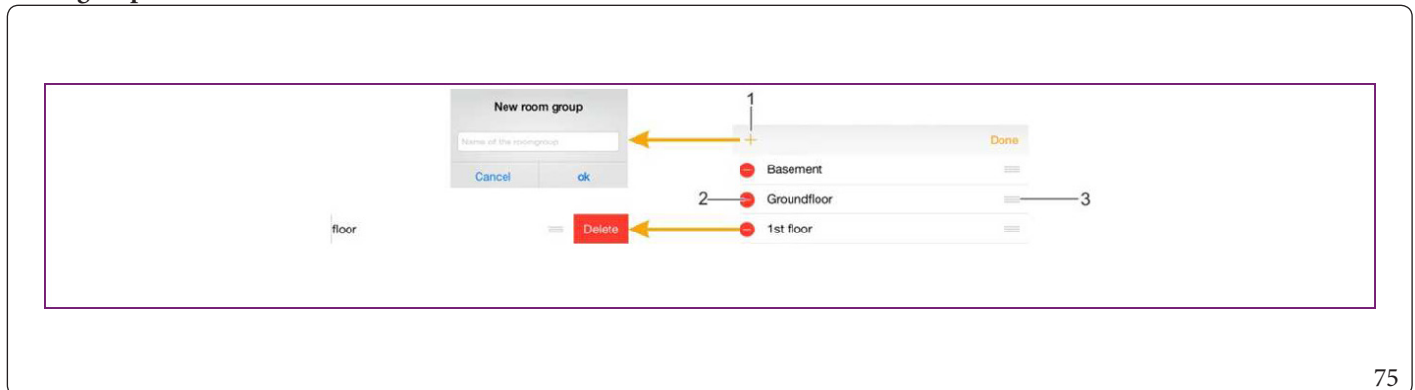

75

Key (Fig. 75):

- 1 - Symbol "Create room group"
- 2 - "Delete room group" icon
- 3 - "Move room group" icon

It is often useful to create room groups. In this way, you can comfortably compile room groups for floors or sensible groupings.

Room groups create and edit

1. In the "Rooms" area, tap the "Edit room groups" icon. A dialogue window with the existing room groups is displayed.
2. Tap the "+" symbol. The dialogue window "Create room group" is displayed.
3. Enter the name of the room group and confirm the entry with "Ok".

The room group has been created and is now available.

- To delete a room group, tap the "-" symbol.
- To rename a room group, tap the name of the room group.
- To move a room group, tap the "Move room group" icon and drag the room group to the desired position in the list.

4. Tap on "Done" to apply the settings.

You can now move the rooms between the room groups using Drag&Drop.

User manage

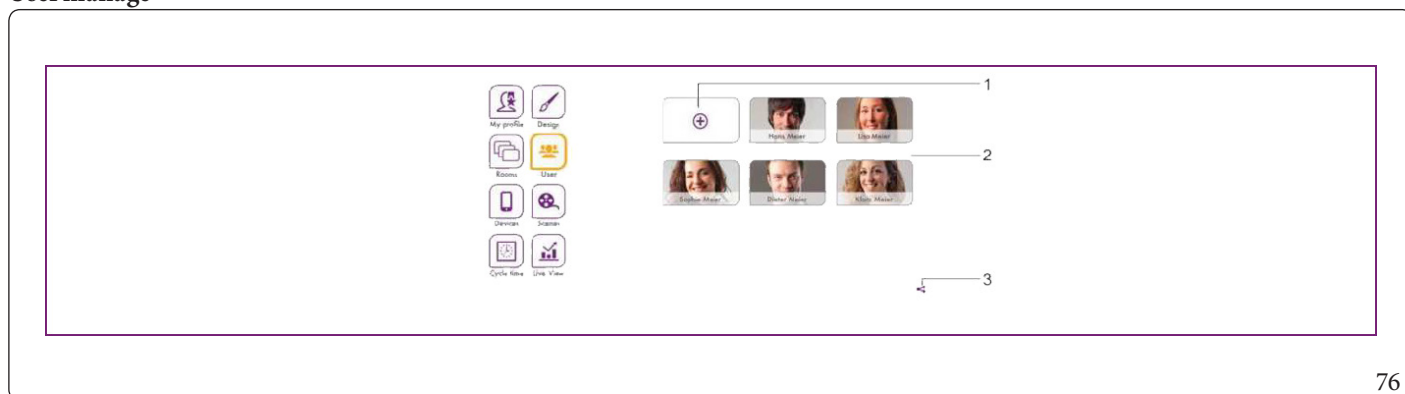

76

Key (Fig. 76):

- 1 - Symbol "Create user"
- 2 - User list
- 3 - "Invite to heatapp! connect" icon

In the "Users" area, all created users are displayed with the exception of the user currently logged in. Users can be created and edited in the "Users" area.

Here you can also send invitations to **heatapp!** connect to other users.

Each user is assigned a user role. The following user roles are available:

- Administrator / Owner
- Technician / Expert
- User

User create

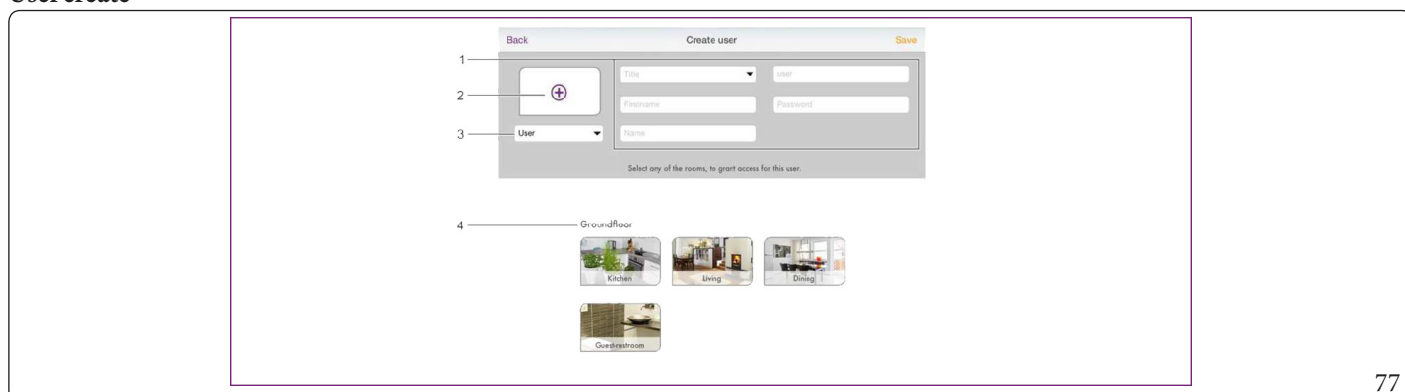

77

Key (Fig. 77):

- 1 - Personal data
- 2 - Profile picture
- 3 - User role
- 4 - Room list

1. Tap the "Create user" icon in the "Users" area. The dialogue window "Create user" is displayed.
2. Select the user role for the new user.
3. Enter the personal data in the input fields and select a user name and password.
4. Tap on the rooms that are to be assigned to the user. To select all rooms in a group, tap on the name of the room group. Swipe horizontally to switch through the room groups.
5. Tap on "Save" to create the user. Tapping on "Back" cancels the creation of a user.

Edit user data, delete user

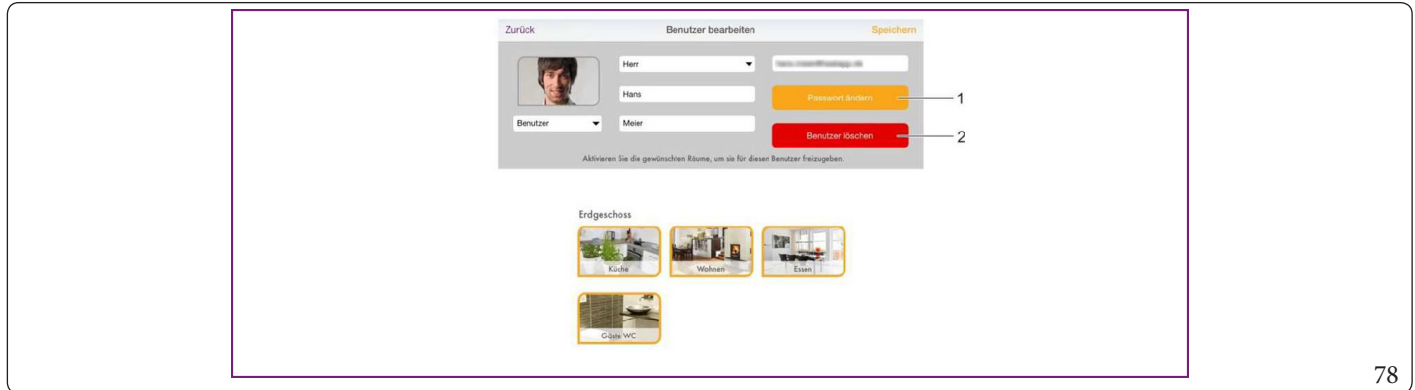

78

Key (Fig. 78):

- 1 - "Change password" button
- 2 - "Delete user" button

Editing a user is done in the same way as creating a user.

There are only two additional buttons for changing the password and deleting the user.

1. Tap on a user in the "Users" area. The "Edit User" dialogue box is displayed.
2. Make the desired changes.
3. Tap on "Save" to apply the changes. Tapping on "Back" discards the changes.



The user data of the respective logged-in user are changed in the "My Profile" area.

Invite users to heatapp! connect invite

With **heatapp! connect**, it is possible to operate the **heatapp!** system from anywhere. No matter where you are, you can access your heating system via the app.

In the "Settings / Users" area, the share icon  is located at the bottom right. Tap the icon  to open the menu "Invite to heatapp connect".

Have the QR code scanned directly with another operating device or tap the "Send e-mail" button and enter the desired e-mail address. Then tap the "Send" button.

The invited user must have the app installed on his end device in order to use **heatapp! connect**. He needs the access data for his user account independently of the invitation. Please inform him of these separately.

The invited user links the installation to the app by tapping the "Accept invitation" button in the email or by scanning the QR code in the email with their operating device.



The app must be downloaded separately from the Apple AppStore or Google Play Store on each end device (smartphone/tablet). The invitation links the app to the installation. The access data for the user must be communicated to the user separately.

Devices manage

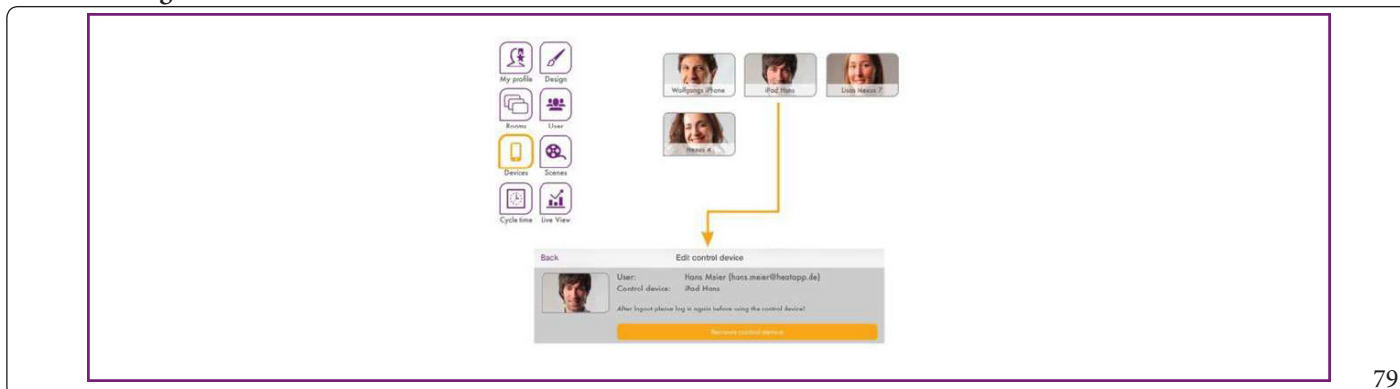

79

In the "Devices" area, the operating devices with which the users have logged on to the **heatapp!** are displayed.

All operating devices that have registered / had registered with the customer's **heatapp!** system are displayed here. If a control panel is lost or the administrator / technician wishes to remove a control panel, this is possible here.

Logging out the control unit

1. Touch the control unit you want to remove. The dialogue window "Edit operating device" is displayed. This also shows which user has used the operating device.
2. Tap the "Deregister operating device" button to delete the corresponding operating device from the list. In order to be able to continue using the operating device, it is necessary to log in again with the user name and password.

Scenes Edit

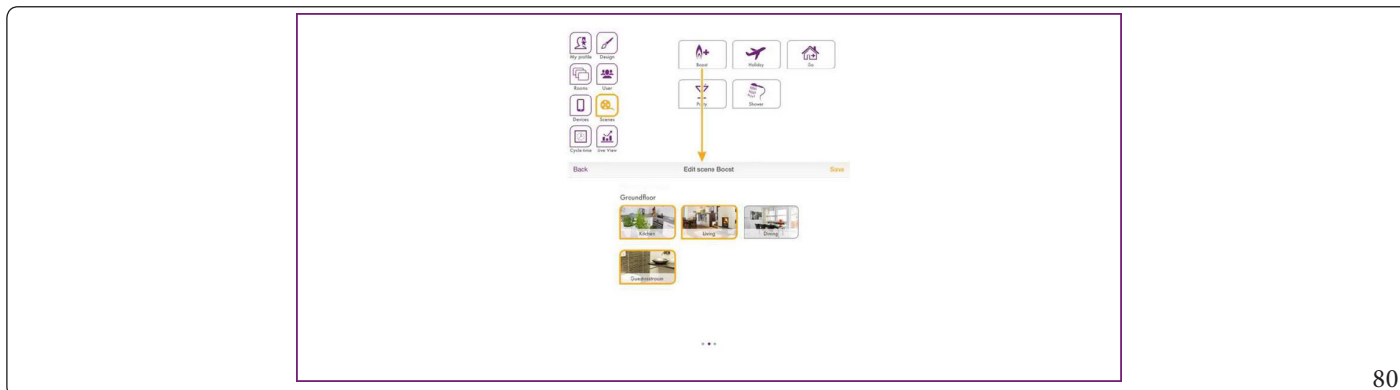

80

In the "Scenes" area, the rooms for which the scenes are to apply are assigned to the scenes.

1. Tap on a scene to open the room assignment.
2. Tap on the rooms that are to be assigned to the respective scene. Swipe horizontally to change through the room groups. Selected rooms are outlined in orange.
3. Tap on "Save" to apply the settings for the room. Tapping on "Back" discards the changes.



If a user activates a scene, the scene is only activated for the rooms that have been assigned to the user. Example:
The Boost scene was assigned to all rooms.

However, only the rooms "Living room" and "Kitchen" have been assigned to the user. If the user activates the "Boost" scene, the scene is also only activated for the rooms "Living room" and "Kitchen".

Switching times edit

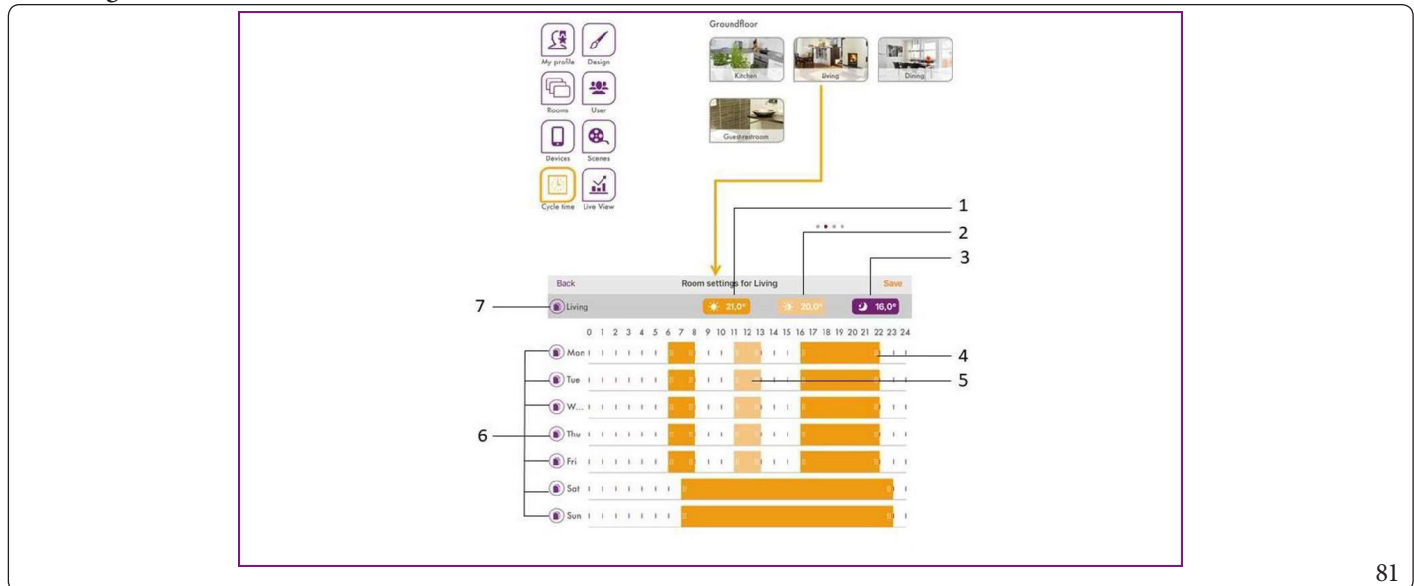

81

Key (Fig. 81):

- 1 - Setting the comfort temperature
- 2 - Setting the economy temperature
- 3 - Setting the setback temperature
- 4 - Switching time "Comfort temperature active"
- 5 - Switching time "Economy temperature active"
- 6 - Copy switching times (by day)
- 7 - Copying switching times (room by room)

In the "Switching times" area, the switching times for the comfort, economy and setback temperatures can be set separately for each room.

A maximum of three switching times can be set per day. In areas where no switching time is set, the heatapp! system regulates the selected room to setback temperature.

The following basic settings are preset:

- Comfort temperature (symbol sun): 21.0 °C
- Saving temperature (symbol half sun): 20 °C
- Lowering temperature (moon symbol): 18.0 °C
- Heating hours: Monday to Sunday between 06.00 and 22.00 hrs.

The switching times for hot water can be reached by swiping horizontally. A maximum of three switching times can be created per day. Between the switching times, the system regulates the hot water temperature to the setback temperature.

The following basic settings are preset:

- Hot water day setpoint temperature (sun symbol): 50 °C
- Hot water night setpoint temperature (moon symbol): 40 °C

Switching times edit

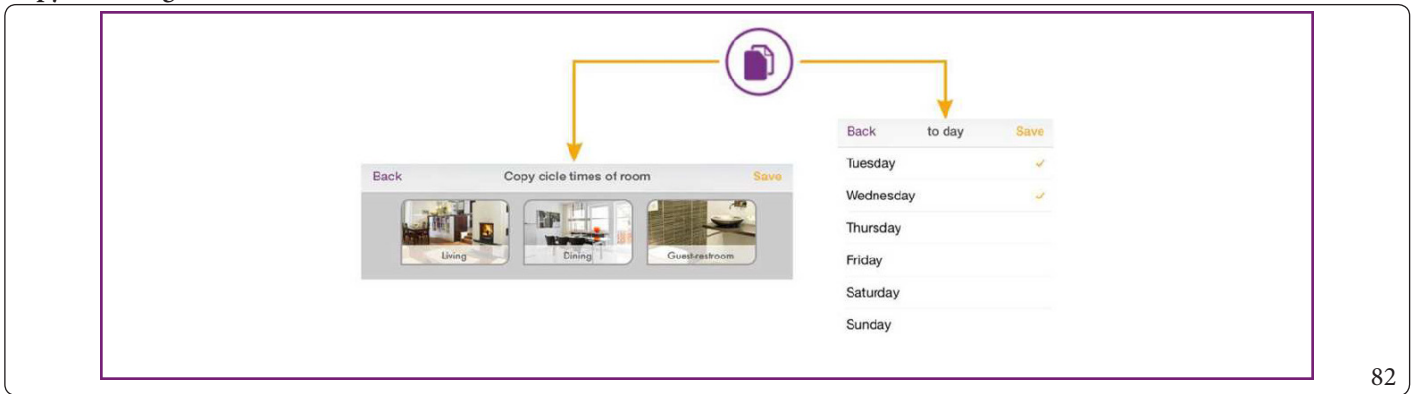

1. Tap on a room in the "Switching times" area. The dialogue window "Switching times for ..." is displayed.
 - To insert a switching time, tap in a free area of the time scale of the desired day and drag on a new switching time.
 - To move a switching time, tap in the middle of the switching time and drag the switching time to the desired position.
 - To change a switching time, drag the ends of the switching time to the desired time.
 - To delete a switching time, pull the ends of the switching time together.
2. Tap on "Save" to apply the settings for the room. Tapping on "Back" discards the changes.

Copy switching times



82

Switching times can be copied room by room and day by day.

1. Tap on a room in the "Switching times" area. The dialogue window "Switching times for ..." is displayed. Tap the symbol  in front of the room name if you want to transfer the switching times of the selected room to other rooms. Tap the symbol  in front of the day if you want to transfer the switching times of the selected day to other days.
2. In the dialogue window, tap on the rooms or days to which the switching times are to be transferred. Multiple selection is possible.
3. Tap on "Copy" to transfer the switching times. Tapping on "Back" cancels the process.

Live View

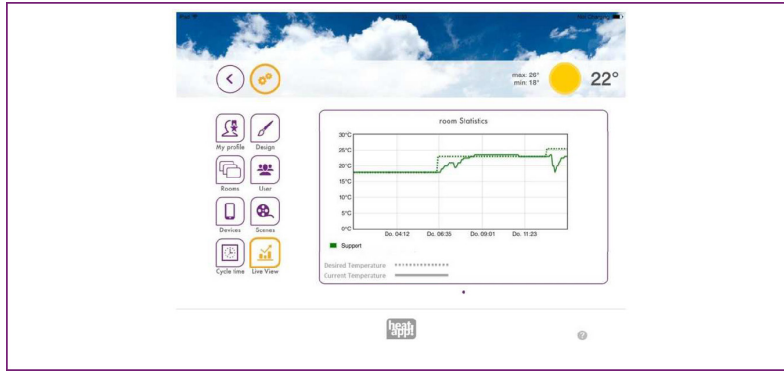

83

In Live View, the statistics of the setpoint and actual values of the last 12 hours are displayed. Long-term statistics can be displayed using the monitor. See also chapter.

In case of connection to the energy generator via BUS, the hot water supply and the energy generator are also displayed, and if available the energy generators.



84

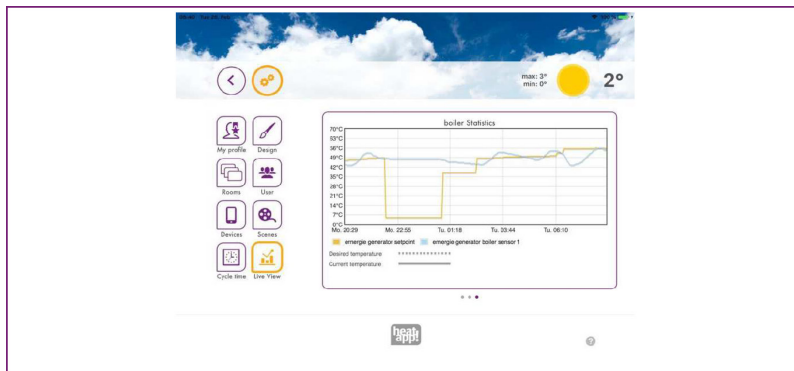

85

The "Live View" area shows the chronological progression of the desired and the Current temperature of the selected rooms, water heating and the energy generator.

1. By swiping horizontally, you can switch between rooms, hot water and energy generator.
2. To change rooms, tap the symbol at the bottom right.
3. Select the rooms for which Live View is to be displayed.
4. Tapping on "Save" saves the data. The process is cancelled with "Back".



A maximum of five rooms can be selected for simultaneous display so that the display does not become too confusing.

INSTALLER

USER

19^{NOTES}



This instruction booklet is made of ecological paper.

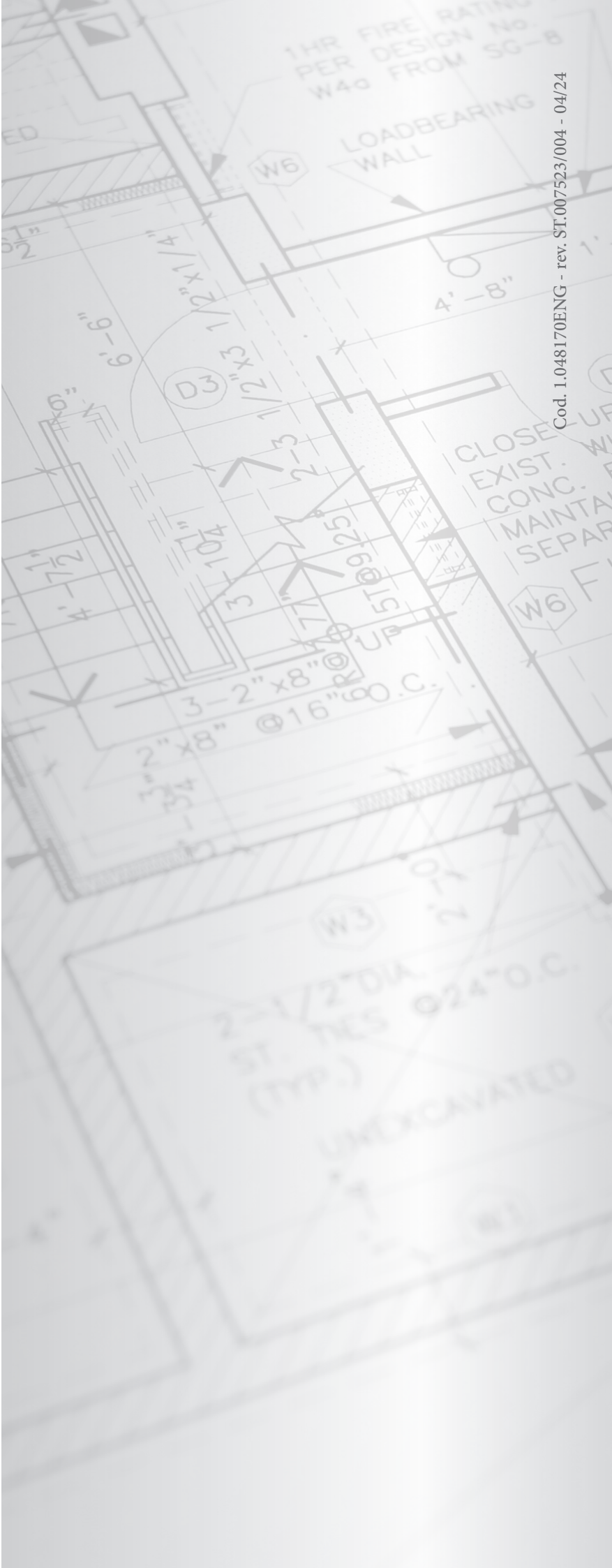

Cod. 1.048170ENG - rev. ST.007523/004 - 04/24